

YAMAHA

*Digital Sound Field Processor
Operation Manual*

DSP-100

HALL 1 HALL 2 HALL 3
CHURCH
CHAMBER
ROCK CNCT

JAZZ CLUB 1

DISCO

MOVIE 1 JAZZ CLUB 2

MOVIE 1 MOVIE 2
DOLBY SUR

Congratulations!

You are the proud owner of a Yamaha DSP-100 Digital Sound Field Processor—an extremely sophisticated audio component.

The DSP-100 takes full advantage of Yamaha's undisputed leadership in the field of digital audio processing to bring you a whole new world of aural experience. Follow the instructions given in this manual carefully when setting up your system, and the DSP-100 will let you "sonically" transform your room into a vast range of high-quality listening environments—large and small. Hear a Beethoven symphony the way it actually sounds at a famous concert hall, enjoy your favorite trio in the cozy acoustic environment of a jazz club, experience the power of rock in a huge hall... In short, you can simply select the acoustic environment that most ideally suits you and your music. And, of course, since all signal processing is digital, the sound is simply superb.

Rather than tell you about the wonders of the DSP-100, however, let's get right down to the business of setting up the system and trying out the basic programs. Please read this operation manual carefully, and store it in a safe place for later reference.

PRECAUTIONS & SAFETY INSTRUCTIONS

SAFETY INSTRUCTIONS

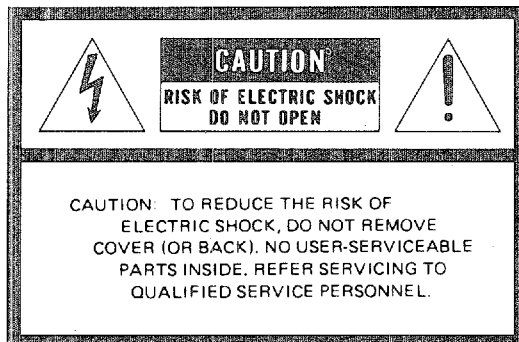

•Explanation of Graphical Symbols



The lightning flash with arrowhead symbol, within an equilateral triangle, is intended to alert you to the presence of uninsulated "dangerous voltage" within the product's enclosure that may be of sufficient magnitude to constitute a risk of electric shock to persons.

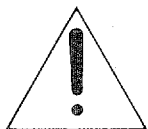

The exclamation point within an equilateral triangle is intended to alert you to the presence of important operating and maintenance (servicing) instructions in the literature accompanying the appliance.

WARNING

To reduce the risk of fire or electric shock, do not expose this appliance to rain or moisture.

1 Read Instructions—All the safety and operating instructions should be read before the appliance is operated.

2 Retain Instructions—The safety and operating instructions should be retained for future reference.

3 Heed Warnings—All warnings on the appliance and in the operating instructions should be adhered to.

4 Follow Instructions—All operating and other instructions should be followed.

5 Water and Moisture—The appliance should not be used near water—for example, near a bathtub, washbowl, kitchen sink, laundry tub, in a wet basement, or near a swimming pool, etc.

6 Cart and Stands—The appliance should be used only with a cart or stand that is recommended by the manufacturer.

6A An appliance and cart combination should be moved with care. Quick stops, excessive force, and uneven surfaces may cause the appliance and cart combination to overturn.



7 Wall or Ceiling Mounting—The appliance should be mounted to a wall or ceiling only as recommended by the manufacturer.

8 Ventilation—The appliance should be situated so that its location or position does not interfere with its proper ventilation. For example, the appliance should not be situated on a bed, sofa, rug, or similar surface that may block the ventilation openings; or cabinet that may impede the flow of air through the ventilation openings.

9 Heat—The appliance should be situated away from heat sources such as radiators, stoves, or other appliances that produce heat.

10 Power Sources—The appliance should be connected to a power supply only of the type described in the operating instructions or as marked on the appliance.

11 Power-Cord Protection—Power-supply cords should be routed so that they are not likely to be walked on or pinched by items placed upon or against them, paying particular attention to cords at plugs, convenience receptacles, and the point where they exit from the appliance.

12 Cleaning—The appliance should be cleaned only as recommended by the manufacturer.

13 Nonuse Periods—The power cord of the appliance should be unplugged from the outlet when left unused for a long period of time.

14 Object and Liquid Entry—Care should be taken so that objects do not fall into and liquids are not spilled into the inside of the appliance.

15 Damage Requiring Service—The appliance should be serviced by qualified service personnel when:

- A. The power-supply cord or the plug has been damaged; or
- B. Objects have fallen, or liquid has been spilled into the appliance; or
- C. The appliance has been exposed to rain; or
- D. The appliance does not appear to operate normally or exhibits a marked change in performance; or
- E. The appliance has been dropped, or the cabinet damaged.

16 Servicing—The user should not attempt to service the appliance beyond those means described in the operating instructions. All other servicing should be referred to qualified service personnel.

17 Power Lines—An outdoor antenna should be located away from power lines.

18 Grounding or Polarization—Precautions should be taken so that the grounding or polarization of an appliance is not defeated.

19 This equipment generates and uses radio frequency energy and if not installed and used properly, that is, in strict accordance with the manufacturer's instructions, may cause interference to radio and television reception. It has been type tested and found to comply with the limits for a Class B computing device in accordance with the specifications in Subpart J of Part 15 of FCC Rules, which are designed to provide reasonable protection against such interference in a residential installation. However, there is no guarantee that interference will not occur in a particular installation. If this equipment does cause interference to radio or television reception, which can be determined by turning the equipment off and on, the user is encouraged to try to correct the interference by one or more of the following measures:

- Reorient the receiving antenna
- Relocate the DSP-100 with respect to the receiver
- Move the DSP-100 away from the receiver
- Plug the DSP-100 into a different outlet so that the DSP-100 and receiver are on different branch circuits.

If necessary, the user should consult the dealer or an experienced radio/television technician for additional suggestions. The user may find the following booklet prepared by the Federal Communications Commission helpful: "How to Identify and Resolve Radio-TV Interference Problems". This booklet is available from the U.S. Government Printing Office, Washington, DC 20402, Stock No. 004-000-00345-4.

IMPORTANT!

Please record the serial number of your unit in the space below.

Model: **DSP-100**

Serial No.:

The serial number is located on the rear of the unit. Retain this Owner's Manual in a safe place for future reference.

PRECAUTIONS & SAFETY INSTRUCTIONS

1. AVOID EXCESSIVE HEAT, HUMIDITY, DUST AND VIBRATION

Keep the unit away from locations where it is likely to be exposed to high temperatures or humidity—such as near radiators, stoves, etc. Also avoid locations which are subject to excessive dust accumulation or vibration which could cause mechanical damage.

2. AVOID PHYSICAL SHOCKS

Strong physical shocks to the unit can cause damage. Handle it with care.

3. DO NOT OPEN THE UNIT OR ATTEMPT REPAIRS OR MODIFICATIONS YOURSELF

This product contains no user-serviceable parts. Refer all maintenance to qualified Yamaha service personnel. Opening the unit and/or tampering with the internal circuitry will make servicing difficult and will endanger you and your DSP-100.

4. MAKE SURE POWER IS OFF BEFORE MAKING OR REMOVING CONNECTIONS

Always turn the power OFF prior to connecting or disconnecting cables. This is important to prevent damage to the unit itself as well as other connected equipment.

5. HANDLE CABLES CAREFULLY

Always plug and unplug cables—including the AC cord—by gripping the connector, not the cord.

6. CLEAN WITH A SOFT DRY CLOTH

Never use solvents such as benzine or thinner to clean the unit. Wipe clean with a soft, dry cloth.

7. ALWAYS USE THE CORRECT POWER SOURCE

Make sure that the power source voltage specified on the rear panel matches your local AC mains supply.

8. DO NOT ATTEMPT TO REPLACE THE BACKUP BATTERY YOURSELF

If the backup battery in the main unit should need replacement (“EE” appears on the LED display), have the job done by qualified Yamaha service personnel.

CONTENTS

PRECAUTIONS & SAFETY INSTRUCTIONS	1	SECTION 3—CREATING YOUR OWN SOUND FIELDS ..	32
SECTION 1—SETUP & ADJUSTMENT	4	3-1. SELECTING & EDITING PROGRAM PARAMETERS	32
1-1. GETTING STARTED	4	3-2. EFFECT LEVEL & BALANCE	35
1-2. SETUP	6	3-3. STORING AN EDITED PROGRAM IN THE USER MEMORY	36
1-3. OPTIONAL CONNECTIONS	15	3-4. DESCRIPTIONS OF THE SOUND FIELD PARAMETERS	37
1-4. CONTROLS & ADJUSTMENTS	17		
SECTION 2—GENERAL OPERATION	22	SECTION 4—TABLES AND SPECIFICATIONS	41
2-1. INPUT SOURCE SELECTION	22	4-1. PROGRAM PARAMETER TABLE	41
2-2. PROGRAM AND MEMORY CONFIGURATION	23	4-2. USER PROGRAM TABLE	43
2-3. SELECTING THE PRESET SOUND FIELD PROGRAMS	23	4-3. TROUBLESHOOTING	44
2-4. MUTING THE EFFECT SOUND	24	4-4. SPECIFICATIONS	45
2-5. DESCRIPTIONS OF THE PRESET SOUND FIELD PROGRAMS	25	4-5. BLOCK DIAGRAM	46
2-6. SUPERIMPOSED VIDEO PROGRAM/ PARAMETER DISPLAY	31		

SECTION 1—SETUP & ADJUSTMENT

1-1. GETTING STARTED

Unpacking

If you haven't already done so, carefully remove the DSP-100 and its accessories from the box and wrapping material. You should find the DSP-100 itself, a remote control unit, a pair of batteries for the remote control unit, four pairs of stereo audio cables and a video cable.

Check that you have the following 4 items:

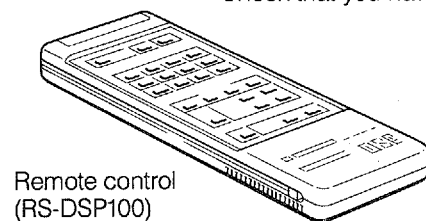

Remote control
(RS-DSP100)

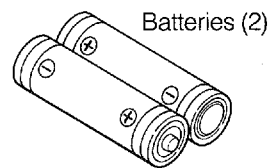

Batteries (2)

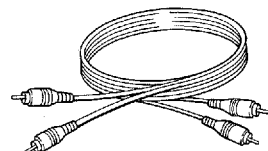

Pin cables, audio (4)

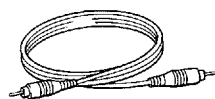

Pin cable, video (1)

Installing the Remote Control Unit Batteries

Since the remote control unit will be used for almost all DSP-100 control operations, you should begin by installing the supplied batteries.

1. Turn the remote control unit over and pull down on the battery compartment cover clip while pulling the compartment cover outward, as shown in the accompanying illustration.
2. Insert the two batteries (SUM-3 or AA types), being careful to align them with the polarity markings on the inside of the battery compartment.
3. Close the battery compartment cover.

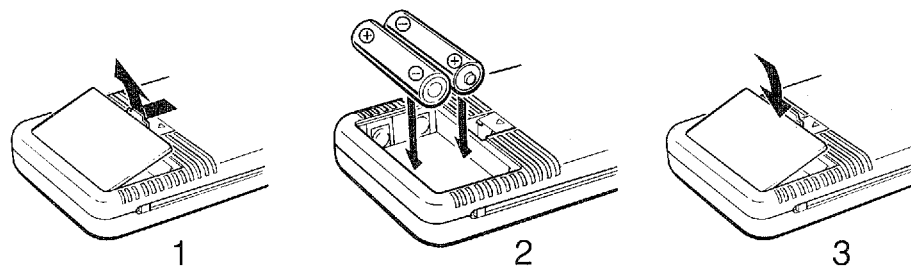

- When you notice that remote control operation has become erratic, or the distance from which the remote control will function has decreased markedly, it's time to replace the batteries. Always replace both batteries with new ones at the same time.

SETUP & ADJUSTMENT

This remote control uses an advanced, highly directional infrared beam.

Be sure to aim the remote control directly at the infrared receiver on the main unit when operating. The remote control will not operate properly if aimed away from the receiver or if strong light falls on the receiver.

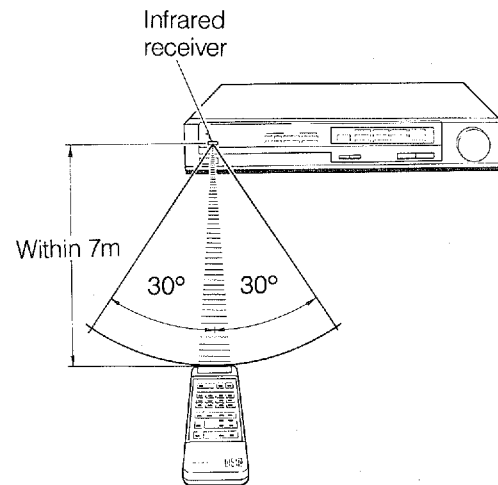

4-channel or 6-channel Operation?

The DSP-100 was designed to provide the best sound-field quality with a full six-channel amplifier and speaker configuration, using two stereo power amplifiers in addition to the main stereo amplifier, and two extra pairs of speakers (two main speakers and four effect speakers). We therefore recommend that you use a six-channel setup, and we'll base our system setup instructions on the six-channel configuration. A four-channel system using only one extra stereo power amplifier and one pair of speakers for the effect sound will still provide impressive ambience and effects, however, and may be a good way to begin with your DSP-100. You can always upgrade to the full six channels later. In the 4-channel mode, the full 6-channel processing is still performed, but with the front speakers used both for the main channels and the front effect channels.

4CH
□ □
□ □ Notes on four-channel setup will be given alongside the "4CH" symbol shown here.

SETUP & ADJUSTMENT

1-2. SETUP

Before You Start Making Connections Make Sure All Related Electronic Components are Turned OFF.

REAR PANEL

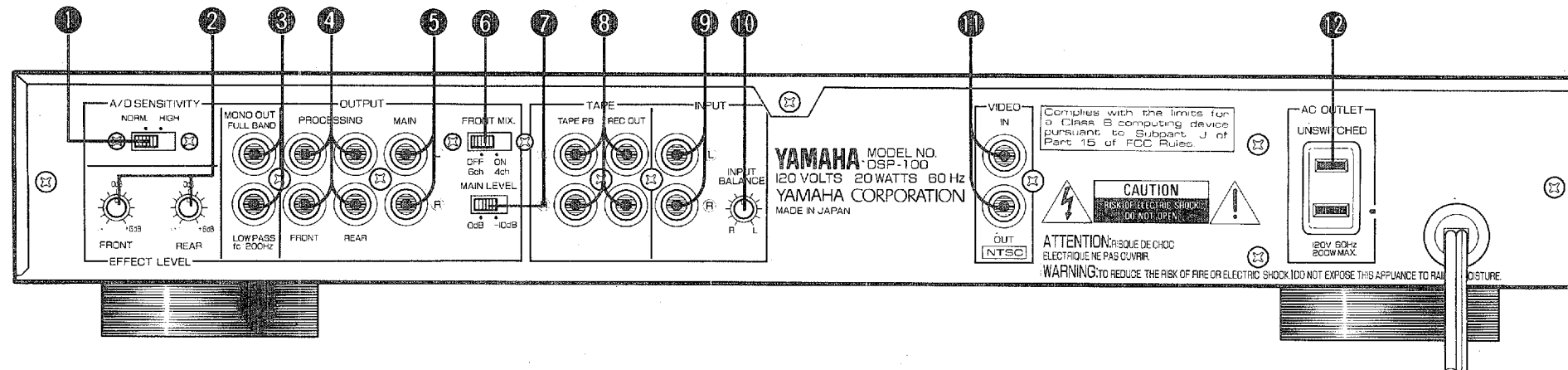

① A/D Sensitivity Switch

Can be used to increase the input sensitivity of the internal analog-to-digital convertor. Usually set to the NORM position, but can be set to HIGH to increase sensitivity. This is useful when for some reason you find it desirable to turn down the volume using the volume control on your preamplifier.

② Front and Rear Effect Level Controls

Used for adjusting the volume level from the effect speakers when there is no volume level on the effect channel power amplifier. Set to the center position when not being used.

③ Mono Auxiliary Amp/Speaker Outputs

Output to optional center-channel or subwoofer auxiliary power amplifiers and speakers. Separate terminals are provided for FULL BAND (all frequencies) and LOW PASS (frequencies below 200 Hz only).

④ Front and Rear Effect Outputs

Output to the FRONT and REAR effect power amplifiers (REAR only in the case of a 4-channel system).

SETUP & ADJUSTMENT

- ⑤ **Main Outputs**
Output to the main power amplifier or to the "MAIN IN" terminals on an integrated amplifier.
- ⑥ **Front Mix Switch**
Set to "6ch" when setting up a full 6-channel system, or to "4ch" when using only four speakers in a 4-channel system.
- ⑦ **Main Level Switch**
Can be used to reduce MAIN output level by 10 dB to match the MAIN and EFFECT speaker levels.
- ⑧ **Tape Rec Out and Playback Terminals**
Accept the inputs and outputs of a stereo tape deck for convenient recording and playback via the DSP-100 (the effect sound cannot be recorded).
- ⑨ **Input Terminals**
Accept input from a preamplifier, the "PRE OUT" or "TAPE REC" outputs from an integrated amplifier, or direct input from a line-level source.
- ⑩ **Input Balance Control**
Used for adjusting the input balance for optimum Dolby surround decoding if the source being used is out of balance. Set to the center position when not being used.
- ⑪ **Video Input and Output Terminals**
These terminals connect the DSP-100 between your VCR or video disc player and video monitor, allowing DSP-100 programs and data to be displayed on the video monitor screen.
- ⑫ **Auxiliary AC Outlet**
This AC outlet may be used to power other components in your audio system as long as the total power consumption of the connected equipment does not exceed 200 watts.

SETUP & ADJUSTMENT

Rear-Panel Switch and Control Settings

There are several switches and controls on the DSP-100 rear panel that you'll have to check before operating your system, and it's a good idea to do it before you connect cables. Locate the "MAIN LEVEL" ⑦ and "FRONT MIX" ⑥ slide switches on the right hand side of the OUTPUT terminal group. Make sure that the "MAIN LEVEL" switch is set to its "0 dB" position and the "FRONT MIX" switch is set to "6ch" for six-channel operation.

 In a 4-channel system, set the FRONT MIX switch to "4ch."

Next, be sure that the A/D SENSITIVITY switch ① is set to the NORM position. This switch should only be set to HIGH if for some reason you find it necessary to reduce volume by turning down the volume control on your preamplifier. Finally, make sure that both EFFECT LEVEL controls ② and the INPUT BALANCE control ⑩ are set to their center positions.

Speakers & Speaker Placement

Your six-channel system will require three speaker pairs: the MAIN SPEAKERS (your normal stereo speakers), the FRONT EFFECT SPEAKERS, and the REAR EFFECT SPEAKERS. Use your best speakers for the MAIN SPEAKERS—that is, the ones with the best overall frequency response, sound quality, and highest power handling capacity. The other four speakers (the FRONT EFFECT pair and the REAR EFFECT pair) do not have to be of such high quality, but they should at least have a reasonably broad, flat frequency response, and be able to handle the maximum power output of the effect power amplifiers without distortion or damage.

The MAIN SPEAKERS should be placed where you would normally place your stereo speaker system. They should be far enough apart to produce good stereo imaging, and should be equal distances from your listening position. The only difference is that, if possible, the MAIN SPEAKERS should be placed 3 to 6 feet away from the front wall of the listening room.

The FRONT EFFECT SPEAKERS should be placed further apart than the MAIN SPEAKERS. They should be placed on either side of, a few feet above and behind the MAIN SPEAKER pair (that's why the main speakers should be a few feet from the wall).

The REAR EFFECT SPEAKERS should be placed behind and facing the listening position, at about the same distance apart and height as the FRONT EFFECT SPEAKER pair.

Since the DSP-100 digitally synthesizes a variety of acoustic environments for you, a better effect is obtained if your listening room is as acoustically "dead" as possible. That is, it should have a minimum of hard, reflective surfaces. A carpeted

SETUP & ADJUSTMENT

floor is better than a hard wood or tile floor, large areas of window glass should be covered by curtains, etc. These precautions are not absolutely essential, but they will let you enjoy the maximum possible performance from the DSP-100.

 A four-channel system requires only two speaker pairs: the MAIN SPEAKERS and the REAR EFFECT SPEAKERS. Use your best speakers for the MAIN SPEAKERS.

The MAIN SPEAKERS should be placed where you would normally place your stereo speaker system. They should be far enough apart to produce good stereo imaging, and should be equal distances from the listening position.

The REAR EFFECT SPEAKERS should be placed behind and facing the listening position. They should be a little further apart and a few feet higher than the MAIN SPEAKER pair.

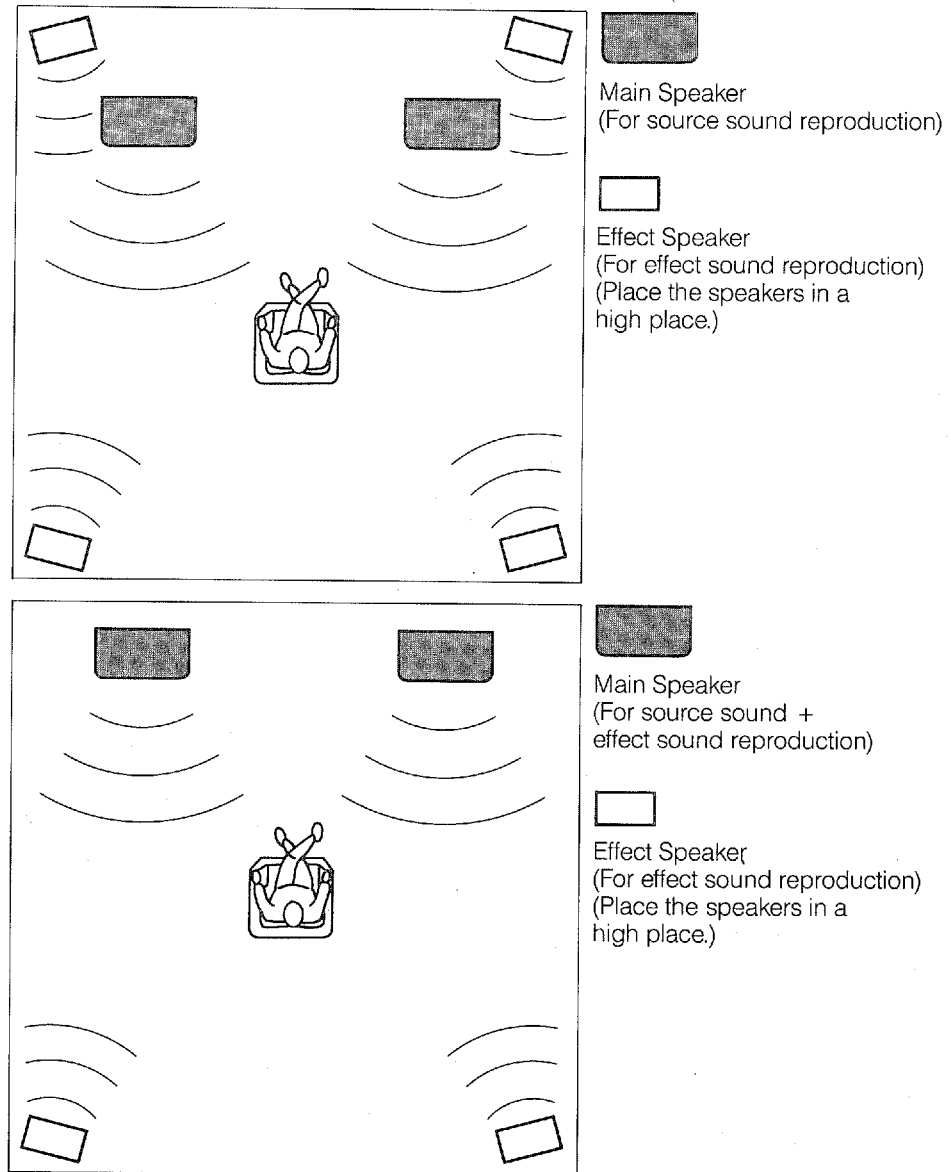
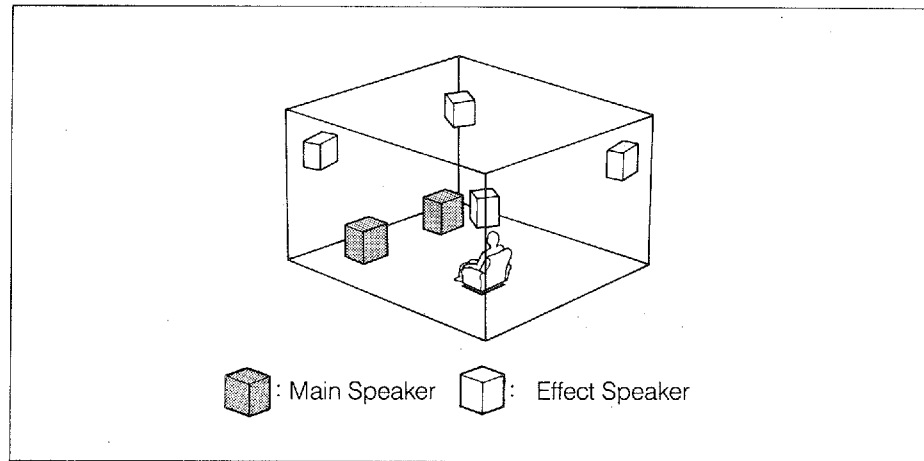

SETUP & ADJUSTMENT

CONNECTING THE MAIN INTEGRATED STEREO AMPLIFIER, STEREO RECEIVER OR COMPONENT PREAMPLIFIER AND POWER AMPLIFIER TO THE DSP-100

Using an Integrated Amplifier or Stereo Receiver with "PRE OUT" and "MAIN IN" Terminals

Some integrated amplifiers and stereo receivers have PRE OUT and MAIN IN terminals which permit the preamplifier and power amplifier sections to function independently. If your integrated amplifier or stereo receiver has these terminals, begin by removing the jumpers that connect the PRE OUT and MAIN IN terminals (or de-couple the preamplifier and power amplifier using the appropriate switch—refer to your amplifier or receiver operation manual).

- Connect the amplifier's PRE OUT terminals to the leftmost pair of DSP-100 INPUT terminals with a stereo pin cable. Make sure the "L" output from the amplifier is connected to the "L" input on the DSP-100, and that the "R" output from the amplifier is connected to the "R" input on the DSP-100.
- Connect the MAIN OUTPUT terminals on the DSP-100 to the MAIN IN terminals on your integrated amplifier or receiver with a second stereo pin cable—making sure to connect the left and right channels correctly.
- Connect the MAIN speakers to the speaker output terminals of your integrated amplifier or receiver.

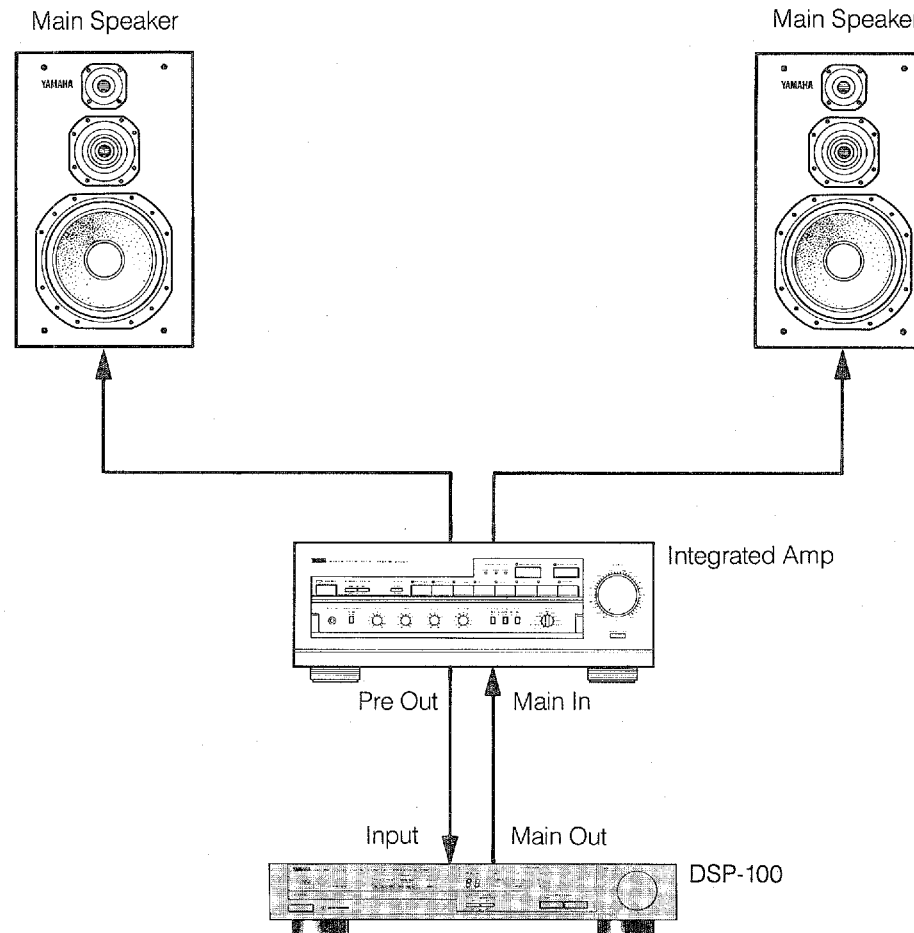

SETUP & ADJUSTMENT

Using an Integrated Amplifier or Stereo Receiver that Does NOT Have "PRE OUT" and "MAIN IN" Terminals

If your integrated amplifier or stereo receiver is NOT equipped with PRE OUT and MAIN IN terminals, the DSP-100 must be connected to the amplifier or receiver tape record and playback terminals. The DSP-100 provides a second tape monitor loop so you won't lose record and tape playback capability by connecting the DSP-100 to your amplifier's tape terminals.

- Connect the amplifier or receiver TAPE REC (or TAPE OUT) terminals to the leftmost pair of DSP-100 INPUT terminals with a stereo pin cable. Make sure the "L" output from the amplifier or receiver is connected to the "L" input on the DSP-100, and that the "R" output from the amplifier or receiver is connected to the "R" input on the DSP-100.
- Connect the MAIN OUTPUT terminals on the DSP-100 to the TAPE PLAY (or TAPE IN) terminals on your amplifier or receiver with a second stereo pin cable—making sure to connect the left and right channels correctly.
- Connect the MAIN speakers to the speaker output terminals of the amplifier or receiver.

NOTE: If your system includes a tape deck which has been "displaced" by connecting the DSP-100 to the TAPE terminals, reconnect your tape deck to the DSP-100 TAPE PB and TAPE REC OUT terminals. TAPE REC OUT from the DSP-100 goes to the INPUT terminals on your tape deck, and the DSP-100 TAPE PB terminals should be connected to the tape deck's OUTPUT terminals. See "Selecting a Tape Deck Connected to the DSP-100 TAPE Terminals" on page 22.

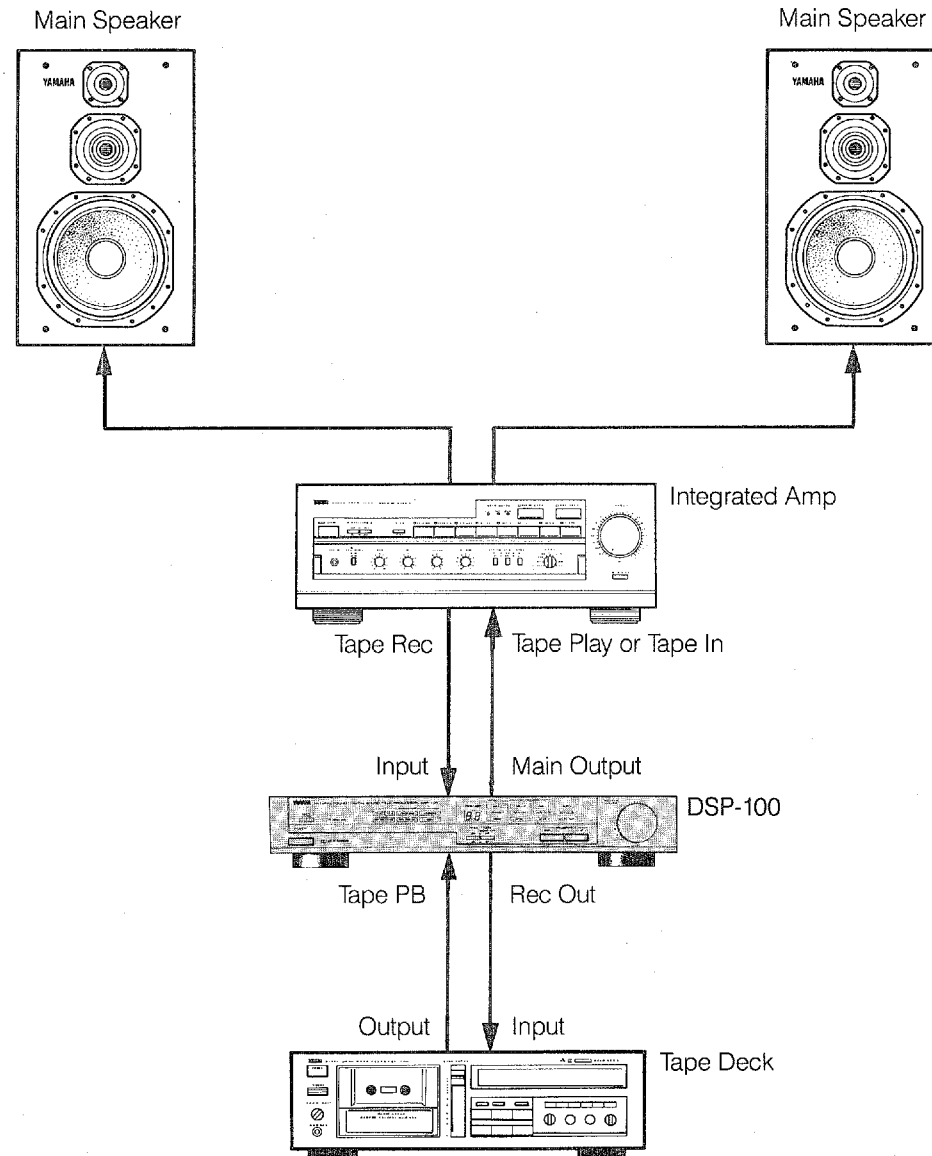

SETUP & ADJUSTMENT

Using a Component Preamp and Power Amplifier

- Connect the preamp's PRE OUT terminals to the leftmost pair of DSP-100 INPUT terminals with a stereo pin cable. Make sure the "L" output from the preamp is connected to the "L" input on the DSP-100, and that the "R" output from the preamp is connected to the "R" input on the DSP-100.
- Connect the MAIN OUTPUT terminals on the DSP-100 to the INPUT terminals on your power amplifier with a second stereo pin cable—making sure to connect the left and right channels correctly.
- Connect the MAIN speakers to the speaker output terminals of the power amplifier.

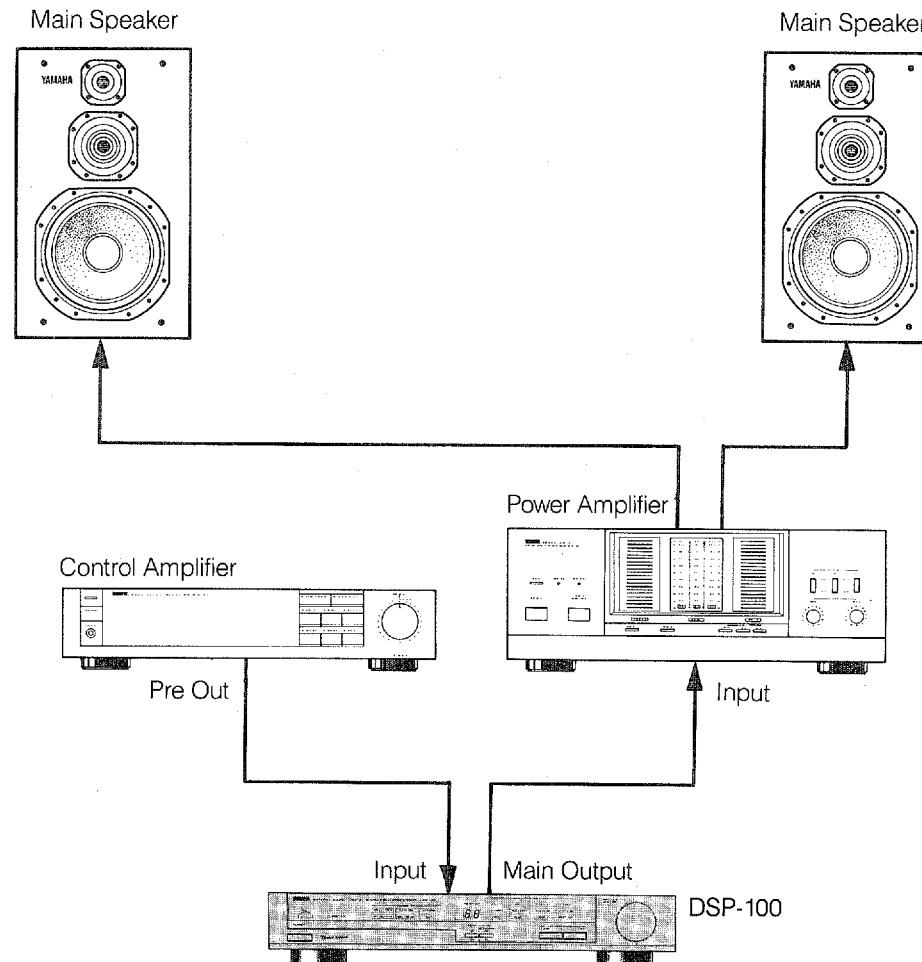

SETUP & ADJUSTMENT

CONNECTING THE EFFECT POWER AMPLIFIER(S) AND SPEAKERS TO THE DSP-100

If you will be using separate stereo power amplifiers for the FRONT and REAR effect speakers, simply connect the FRONT OUTPUT terminals on the DSP-100 to the INPUT terminals of the FRONT power amplifier, and the REAR OUTPUT terminals on the DSP-100 to the INPUT terminals of the REAR power amplifier. The FRONT and REAR effect speakers should be connected to the appropriate speaker terminals of the FRONT and REAR power amplifiers.

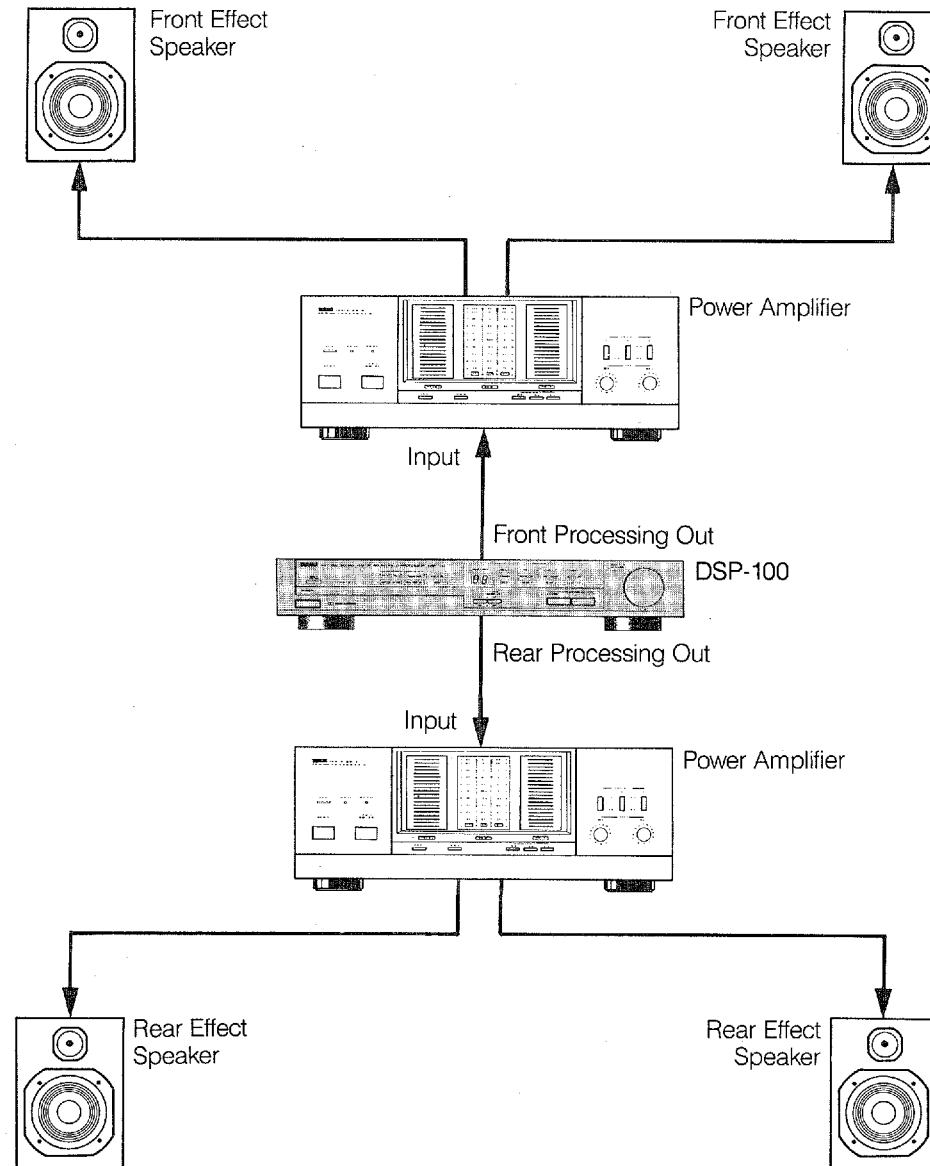

SETUP & ADJUSTMENT

It is also possible to use a four-channel power amplifier to drive both the front and rear effect speakers. In this case you would normally use the first two channels of the power amplifier (channels "1" and "2" or "A" and "B") for the FRONT effect speakers, and the second two channels ("3" and "4" or "C" and "D") for the REAR effect speakers.

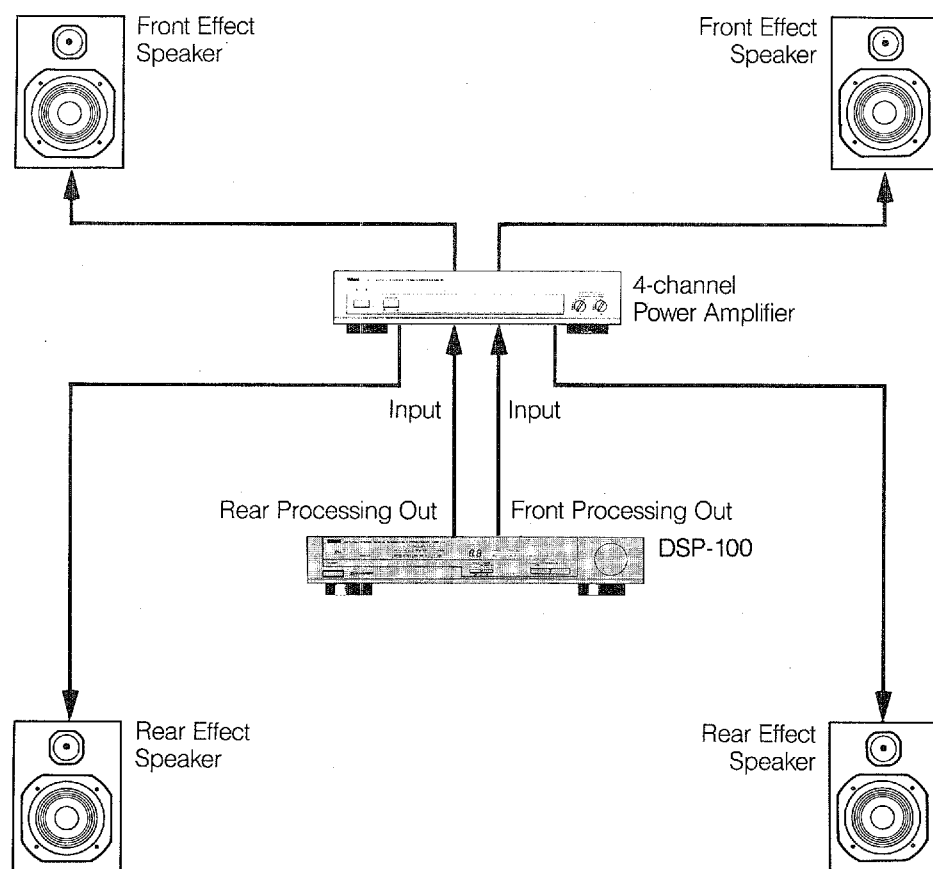

4CH
□ □
□ □

In a four-channel system connect the effect stereo power amplifier to the DSP-100 REAR OUTPUT terminals. Connect the speaker output terminals of the REAR power amplifier to the REAR EFFECT speakers.

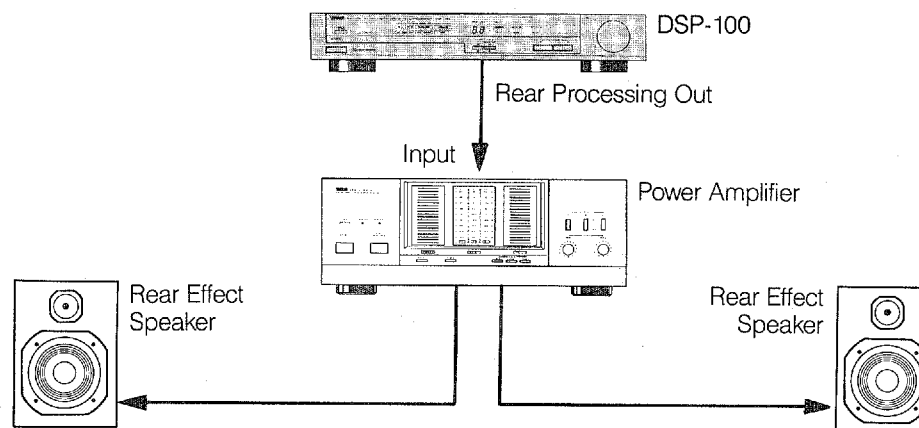

CAUTION: Make absolutely sure that all line-level connections are made between the correct channels (L→L, R→R), and that all speaker connections are phased properly (that is, the red or "+" terminal on the amplifier goes to the red or "+" terminal on the speaker, and the black or "-" terminal on the amplifier goes to the black or "-" terminal on the speaker). Use phase-coded speaker cable (one of the two wires in the cable is a different color or marked with a stripe) to facilitate proper speaker wiring.

SETUP & ADJUSTMENT

1-3. OPTIONAL CONNECTIONS

This section deals with:

- Adding center auxiliary speakers to your system.
- Using the DSP-100 video superimpose capability.

If you do not plan to use any of these capabilities skip ahead to the "CONTROLS & ADJUSTMENTS" section which follows.

ADDING CENTER AUXILIARY SPEAKERS

In particularly large listening rooms you may wish to add auxiliary speakers to "fill in" the overall sound field and reinforce the low-mid frequencies. The DSP-100 provides two independent mono output terminals which can be used with appropriate amplifiers to add center channel speakers in front of the listening room. The FULL BAND terminal outputs a signal which is a combination of the left and right effect channel signals, and can be used with a standard speaker system or woofer (normally placed at the front of the listening room). The LOW PASS output is similar, but contains only frequencies under 200 Hz. This can be used with a woofer or subwoofer.

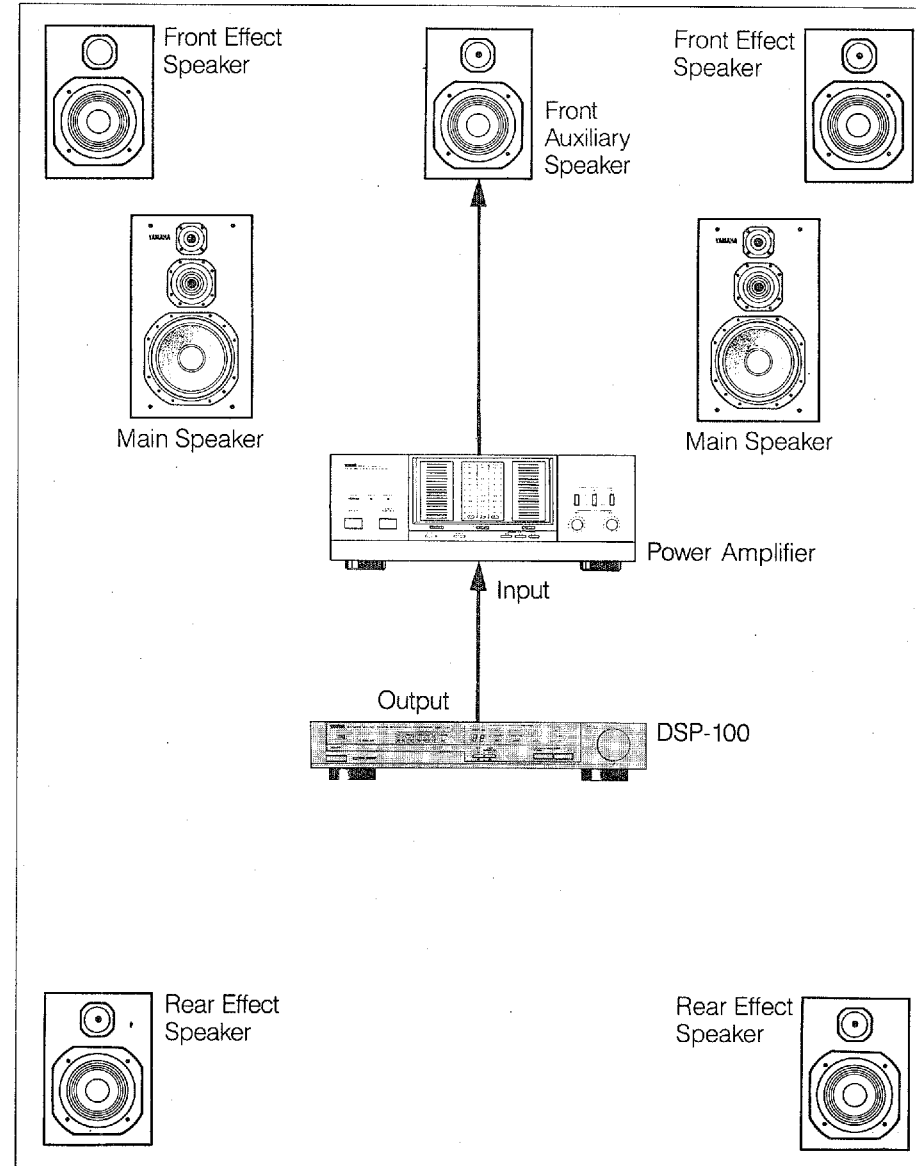

SETUP & ADJUSTMENT

VIDEO SUPERIMPOSE

If your DSP-100 will be used in conjunction with a video system, this connection allows the DSP-100 to display program titles and parameter data on your video monitor screen, superimposed over the video image. Refer to "2-6. SUPERIMPOSED VIDEO PROGRAM/PARAMETER DISPLAY" on page 31 for operational details.

Connect the composite video output from your video cassette recorder or video disc player to the DSP-100 VIDEO IN terminal. The DSP-100 VIDEO OUT terminal should then be connected to the composite video input of your video monitor or TV.

NOTE: The video signal from your video cassette deck or video disc player will not be sent to the video monitor via the DSP-100 VIDEO terminals when the DSP-100 power is OFF.

NOTE: The General Model and Canadian model use the NTSC television system, while other models use the PAL system.

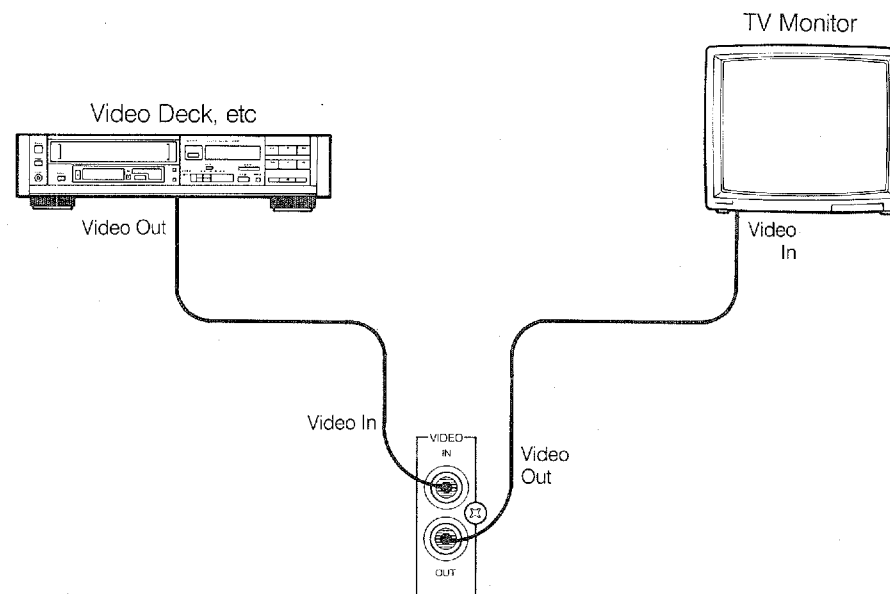

SETUP & ADJUSTMENT

1-4. CONTROLS & ADJUSTMENTS

FRONT PANEL

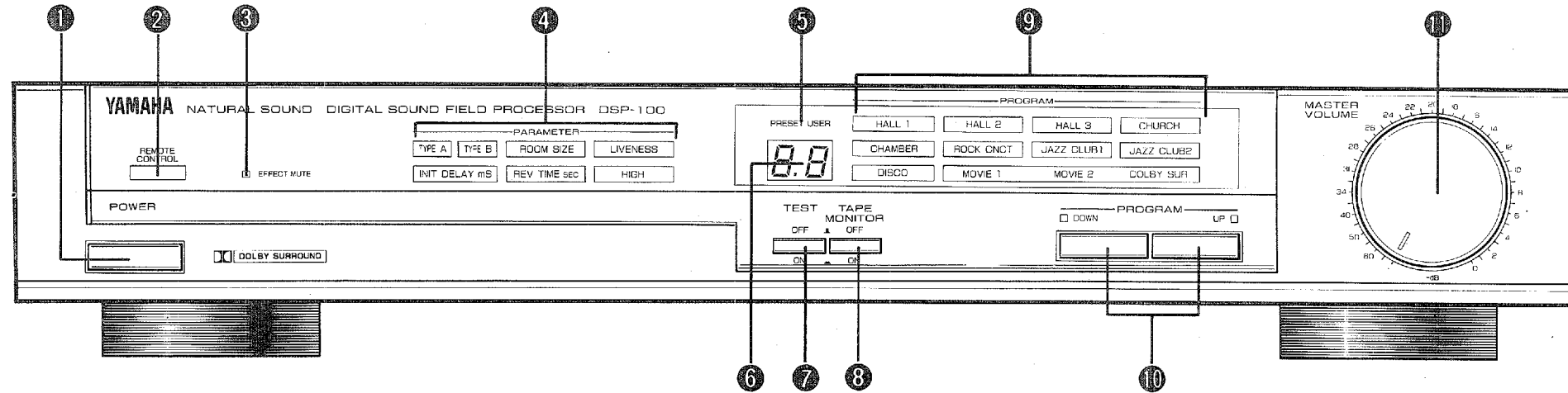

- ① Power Switch
- ② Remote Control Receiver Window
Receives the infra-red data beam from the remote control unit (do not obstruct).
- ③ Effect Mute Indicator
Show when the EFFECT MUTE function is ON.
- ④ Parameter Display
Normally shows whether program Type A or Type B has been selected. When a program parameter is being viewed or altered, shows the name of that parameter.
- ⑤ Preset and User Prog. Indicators
Show whether the PRESET or USER programs are currently selected.
- ⑥ Program Number Display
Shows the number of the currently selected preset or user program. When a program parameter is being viewed or altered, displays its value.
- ⑦ Test Switch
Used for setting the volume levels of the effect speakers for best balance with the main speakers. Sends a test signal to the main, front effect and rear effect speakers in turn, for easy comparison of level settings.
- ⑧ Tape Monitor Switch
Allows selection of a tape deck source connected to the TAPE IN terminals.
- ⑨ Program Name Display
Shows the name of the program currently in effect.
- ⑩ Program Selector
Sequentially selects the preset and user programs in the UP or DOWN direction.
- ⑪ Master Volume Control
Adjusts the master volume level.

SETUP & ADJUSTMENT

REMOTE CONTROL UNIT

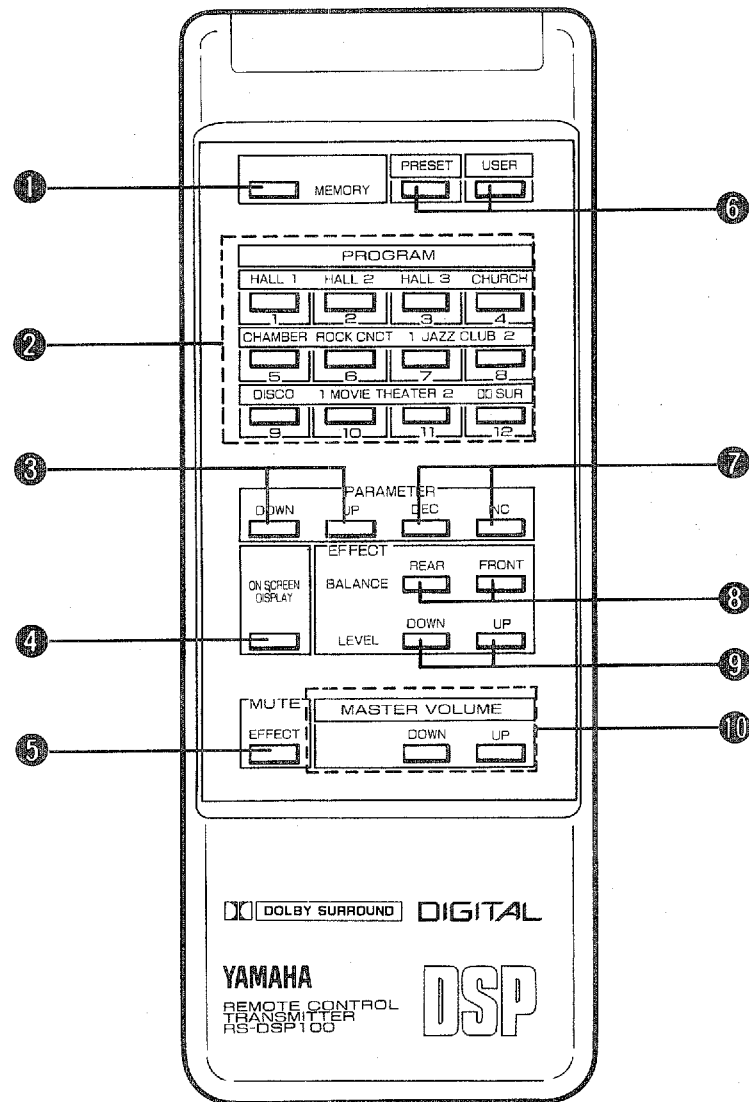

- ① Memory Store (MEMO) Key
Stores an edited sound field program in the user memory.
- ② Program Select Keys (1 through 12)
Select either PRESET or USER programs 1 through 12.
- ③ Parameter Down, Up Keys
Select program parameters.
- ④ On Screen Display Key
Selects whether or not to display the program name and parameters on the connected monitor screen.
- ⑤ Effect Mute Key
Mute the EFFECT speakers for comparison and sound-checks.
- ⑥ Preset and User Program Selector Keys
Select either the PRESET or USER program groups.
- ⑦ Parameter Increment and Decrement Keys
Edit program parameters.
- ⑧ Effect Rear and Front Balance Keys
Adjust the balance between the FRONT and REAR EFFECT speaker levels.
- ⑨ Effect Level Up and Down Keys
Increase (UP) or decrease (DOWN) the level of the EFFECT sound in relation to the MAIN speaker sound.
- ⑩ Master Volume Up and Down Keys
Increase (UP) or decrease (DOWN) the master volume level.

SETUP & ADJUSTMENT

PREPARATION

1. Set all volume controls—on the main amp (preamp) and effect power amplifiers—to their MINIMUM positions.

2. Turn on the power to all system components. The DSP-100 is turned ON by pressing the POWER switch on the front panel.

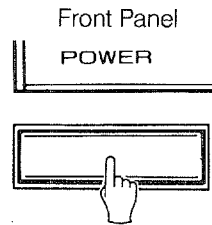

3. Use the MASTER VOLUME control on the DSP-100 front panel or the MASTER VOLUME keys on the remote control unit to set the master volume to its lowest level.

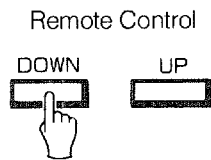

or

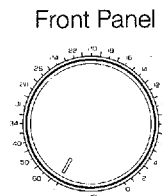

4. Select the desired input source on your preamplifier, integrated amplifier or receiver.

* If you intend to use your tape deck as a source, and it's connected to the DSP-100 TAPE terminals, depress the TAPE MONITOR key on the DSP-100 panel.

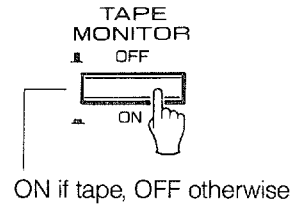

5. Begin playback of the selected source.

6. Increase the setting of the volume control on your preamplifier, integrated amplifier or receiver to about the halfway point.

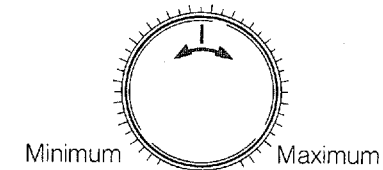

*Depending on the particular model of preamplifier, integrated amplifier, or receiver you are using, a slightly different volume control setting may be necessary. If there is distortion on loud passages, try reducing the volume control setting slightly.

7. Use the MASTER VOLUME control on the DSP-100 front panel or the MASTER VOLUME keys on the remote control unit to set the master volume to a comfortable listening level.

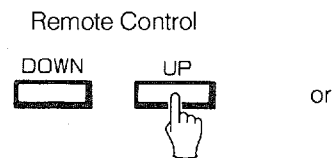

or

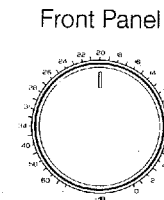

SETUP & ADJUSTMENT

For optimum performance—minimum noise and maximum dynamic range—it is desirable to set the volume control of your preamplifier, integrated amplifier or receiver to its center position, making any necessary adjustments to the listening level by changing the MASTER VOLUME control setting on the DSP-100.

MAIN/EFFECT SPEAKER LEVEL BALANCE ADJUSTMENT

This operation uses an internal pink-noise generator to balance the levels of the MAIN and front and rear EFFECT speakers. It is most convenient to perform this operation using two people, one to adjust the controls of the DSP-100 and amplifiers, and another to sit at the normal listening position and check the balance.

1. Depress the TEST switch on the front panel to enter test mode. A hiss-like calibration signal should be heard from the main speakers, front effect speakers, and rear speakers in turn.

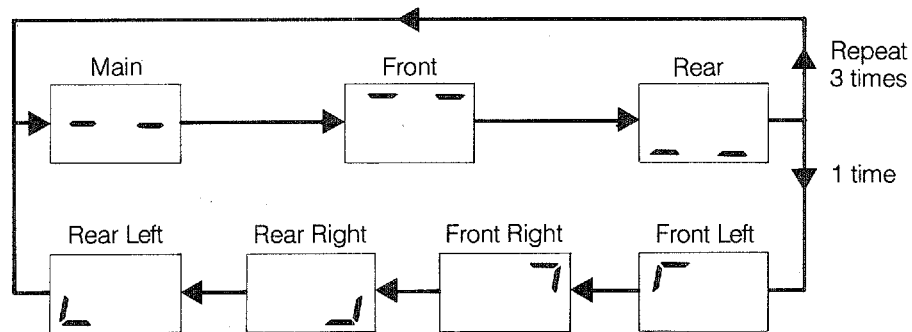

This sequence repeats 3 times, and is followed by another sequence of front left effect, front right effect, rear right effect, and rear left effect (see diagram). Adjust the MASTER VOLUME to a normal listening level.

2. Adjust the volume controls of the amplifiers for the front (for a 6-channel system) and rear effect speakers so that the sound coming from these speakers seems to be at the same level as that from the main speakers when you are at the normal listening position.

3. Adjust the balance controls on the amplifiers so that the left and right speakers are the same volume for each of the main, front, and rear speaker pairs.

Note: If the effect speaker level cannot be made loud enough to match the level from the main speakers, set the MAIN LEVEL switch on the DSP-100 rear panel to the -10 dB position and repeat the calibration process from step 2. If the DSP-100 is connected to the TAPE terminals of an integrated amplifier or receiver, use the amplifier or receiver volume control to decrease the main speaker output level.

4. Press the TEST switch to release it and leave test mode.

SETUP & ADJUSTMENT

IF YOUR EFFECT POWER AMPLIFIERS DO NOT HAVE LEVEL CONTROLS

Although it's best to adjust the effect power amplifier level using controls on the amplifiers themselves, some amplifiers are not equipped with level controls. In this case, use the following alternative level adjustment method.

In the test mode (with the hiss-like calibration signal being output), use the FRONT and REAR EFFECT LEVEL controls on the rear panel of the DSP-100 to adjust the volume of the front and rear effect speakers to be the same as that heard from the main speakers. If the effect level signal cannot be increased enough to match the main speaker output level, set the rear-panel MAIN LEVEL switch to the -10 dB position and try again.

TO ADJUST THE VOLUME USING YOUR EXISTING VOLUME CONTROL

For optimum performance—minimum noise and maximum dynamic range—it is desirable to set the volume control of your preamplifier, integrated amplifier or receiver to its center position, making any necessary adjustments to the listening level by changing the MASTER VOLUME control setting on the DSP-100. However, some DSP-100 listeners will find it more convenient to adjust the preamplifier, integrated amplifier or receiver volume control instead. To do this, use the following procedure:

1. Set the A/D SENSITIVITY switch (1) on the rear panel to the HIGH position.
2. Set the MASTER VOLUME control to its MAXIMUM (0 dB) position.
3. Make all volume adjustments using the volume control on your preamplifier, integrated amplifier, or receiver.

*Changing the setting of the A/D SENSITIVITY does not change the level of the sound heard from the speakers.

*Using the HIGH position causes a reduction in signal-to-noise ratio on the effect channels. If this is bothersome, use the NORMAL position as described on page 8.

SECTION 2—GENERAL OPERATION

2-1. INPUT SOURCE SELECTION

1. Selecting a Source Connected to Your Preamplifier, Integrated Amplifier or Receiver

If the source you wish to hear is connected to your preamplifier, integrated amplifier or receiver then all you need to do is select the desired source using the preamplifier, integrated amplifier or receiver controls.

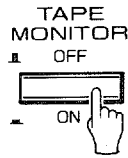

NOTE: When selecting one of the sources described above, make sure that the DSP-100 TAPE MONITOR ON/OFF switch is OFF.

2. Selecting a Tape Deck Connected to the DSP-100 TAPE Terminals

To select a tape deck connected to the DSP-100's TAPE terminals, depress the front-panel TAPE MONITOR switch to turn it ON.

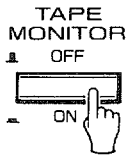

GENERAL OPERATION

2-2. PROGRAM & MEMORY CONFIGURATION

The DSP-100 has two groups of 12 memory locations: 12 preset sound field programs, and 12 user memory locations. You can edit the preset programs to create original sound fields, then store the results in any of the 12 user memory locations for instant recall when needed. The PRESET memory locations cannot be written to or altered in any way.

When the DSP-100 is originally shipped from the Yamaha factory, USER memory locations 1 through 12 contain the same data as in the PRESET memory locations 1 through 12.

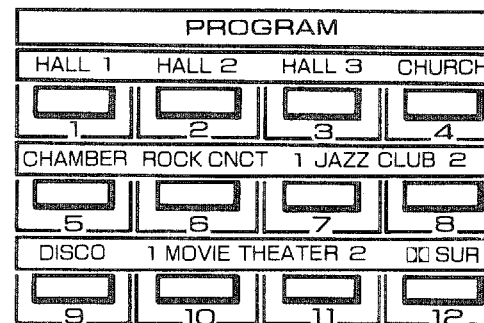

2-3. SELECTING THE PRESET SOUND FIELD PROGRAMS

1. Press the remote control unit PRESET key to ensure that you will select a preset program rather than a user memory location.



2. Select the desired sound field program by pressing the appropriate key on the remote control unit. The selection keys numbered 1 through 12 on the remote control unit allow direct access to the desired program.

* The front-panel PROGRAM UP/DOWN key provides sequential access to both the PRESET and USER programs. Pressing the UP or DOWN end of the PROGRAM key increments (increases) or decrements (decreases) the selected program number, respectively. Hold down the UP or DOWN end of the key for continuous incrementing or decrementing.

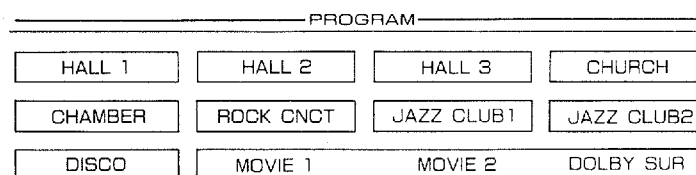

GENERAL OPERATION

3. All preset sound field programs except CHURCH, CHAMBER, and DOLBY SURROUND have two "sub-programs" (see "2-5. DESCRIPTIONS OF THE PRESET SOUND FIELD PROGRAMS," below). The sub-programs are selected using the PARAMETER DEC and INC keys on the remote control unit. The CONCERT HALL 1 program, for example, contains the sub-programs "Hall A in Europe" and "Hall B in Europe." When the CONCERT HALL 1 program is first selected, the "Hall A in Europe" sub-program will be selected and "TYPE A" will be displayed on the front panel. To select "Hall B in Europe," press the PARAMETER INC key. To return to Hall A in Europe, press the PARAMETER DEC key. The same selection procedure applies to all other programs which have sub-programs.

2-4. MUTING THE EFFECT SOUND

The EFFECT MUTE key on the remote control unit makes it simple to compare the normal stereo sound (MAIN) with the fully processed effect sound.

To mute the EFFECT sound and monitor only the MAIN sound, press the MUTE EFFECT key on the remote control unit. The red EFFECT MUTE indicator on the DSP-100 display will light to remind you that the effect sound is muted. Press the EFFECT mute key a second time to restore normal operation.

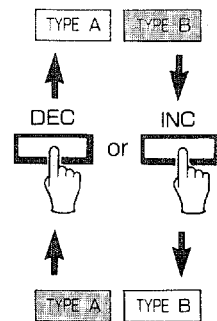

GENERAL OPERATION

2-5. DESCRIPTIONS OF THE PRESET SOUND FIELD PROGRAMS

What is it that makes live music so good? Today's advanced sound reproduction technology lets you get extremely close to the sound of a live performance, but chances are you'll still notice something missing, the acoustic environment of the live concert hall. Extensive research into the exact nature of the sonic reflections that create the ambience of a large hall has made it possible for Yamaha engineers to bring you this same sound in your own listening room, so you'll feel all the excitement of a live concert. What's more, our technicians, armed with sophisticated measuring equipment, have even made it possible to capture the acoustics of a variety of actual concert halls, jazz clubs, theaters, etc. from around the world, to allow you to accurately recreate one of a large variety of actual live performance environments, all in your own home.

The following list gives brief descriptions of the sound field produced by each of the DSP-100 preset programs. Keep in mind that most of these are precise digital recreations of actual acoustic environments, and the data for them was recorded at the locations described using sophisticated Yamaha digital sound field data acquisition equipment.

1. CONCERT HALL 1

TYPE A

Hall A in Europe: This is a fairly common type of concert hall in Europe. It has approximately 2400 seats and features a very beautiful (and acoustically active) wood-panel interior. The overall sound is rich but reserved.

TYPE B

Hall B in Europe: Another wood-interior concert hall that seats a little less than 2500. Polished reflective panelling above the stage produces strong frontal reflections which tend to reinforce the direct sound from the stage. This hall has a very solid, powerful sound.

Preset Parameter	
INIT DLY	30ms
ROOM SIZE	1.0
LIVENESS	5

GENERAL OPERATION

2. CONCERT HALL 2

TYPE A

Hall C in Europe: A classic 1700-seat concert hall with pillars and ornate carvings that, by creating an extremely complex field of reflections arriving from all directions, produces a very full, rich sound.

TYPE B

Hall D in U.S.A.: Another large 2600-seat American hall. This one features a dome over the stage, and seating relatively close to the stage. The sound in this hall is remarkably crisp and precise.

Preset Parameter

INIT DLY	30ms
ROOM SIZE	1.0
LIVENESS	5

3. CONCERT HALL 3

TYPE A

Live Concert: A round concert hall with a rich "surround" effect and pronounced echo.

TYPE B

Hall E in Europe: A smaller 1300-seat hall which uses marble for most interior surfaces. The crisp, clean acoustics of this hall make it a popular location for recording live orchestra performances.

Preset Parameter

INIT DLY	30ms
ROOM SIZE	1.0
LIVENESS	5

GENERAL OPERATION

4. CHURCH

This program recreates the acoustic environment of a modern church with a high pointed dome and columns along the sides. This interior produces very few primary reflections.

Preset Parameter	
INIT DLY	40ms
REV TIME	2.5s
HIGH	0.9

5. CHAMBER

This is the “chamber” that goes with “chamber music.” It is a large regularly shaped room with a high ceiling. A perfect environment for small renaissance and classical ensembles.

Preset Parameter	
INIT DLY	15ms
REV TIME	1.5s
HIGH	0.7

GENERAL OPERATION

6. ROCK CONCERT

TYPE A

Arena: A big, powerful sound suited to rock music.

TYPE B

The Roxy Theatre: The ideal program for lively, dynamic rock music. The data for this program was recorded at LA's "hottest" rock live spot.

Preset Parameter

INIT DLY	15ms
ROOM SIZE	1.0
LIVENESS	9

7. JAZZ CLUB 1

TYPE A

Village Gate: A jazz club in New York. It is in a basement and has a relatively spacious floor area. The reflection pattern is similar to that of a small hall.

TYPE B

Village Vanguard: A traditional New York jazz club located on 7th Avenue. This room has a low ceiling, and the "stage" is located in a corner. This program does not produce nearly as many reflections as the concert hall or church programs, but creates an intimate "close-to-the-music" feel.

Preset Parameter

INIT DLY	20ms
ROOM SIZE	1.0
LIVENESS	5

GENERAL OPERATION

8. JAZZ CLUB 2

TYPE A

Cellar Club: This is a small, cozy jazz club with a low ceiling. The sound is very close and intimate.

TYPE B

Cabaret: The large size of this environment in relation to the other jazz clubs gives it a fuller, richer sound.

Preset Parameter

INIT DLY	20ms
ROOM SIZE	1.0
LIVENESS	5

9. DISCO

TYPE A

New York: Discos tend to have a high-energy, "immediate" sound. This one is no exception. The room itself is circular, approximately 20 meters (65 feet) in diameter.

TYPE B

Tokyo: A lively disco in the heart of a very lively city. The sound is dense and highly concentrated.

Preset Parameter

INIT DLY	10ms
ROOM SIZE	1.0
LIVENESS	6

GENERAL OPERATION

10. MOVIE THEATER 1

TYPE A

Adventure: A sound field ideally suited to viewing action-packed adventure movies.

TYPE B

Standard: This is the sound field most commonly encountered in standard movie theaters.

Preset Parameter

INIT DLY	11ms
ROOM SIZE	1.0
LIVENESS	5

11. MOVIE THEATER 2

TYPE A

Live: By providing clean projection of music and dialogue, this program produces an excellent acoustic environment for viewing live films.

TYPE B

Concert: Projects reverberations over a wide area. Ideal for films of concert scenes.

Preset Parameter

INIT DELAY	20ms
ROOM SIZE	1.0
LIVENESS	5

GENERAL OPERATION

12. DOLBY SURROUND*

A stunning, surrounded-by-sound effect for reproducing video discs, video tapes and similar sources which are Dolby Surround encoded and bear the " DOLBY SURROUND" logo.

* DOLBY SURROUND

Manufactured under license from Dolby Laboratories Licensing Corporation. Additionally licensed under one or more of the following patents: U.S. numbers 3632886, 3746792 and 3959590; Canadian numbers 1004603 and 1037877. "Dolby" and the Double-D symbol are trademarks of Dolby Laboratories Licensing Corporation.

Preset Parameter	
DELAY	20.0ms

NOTE: Dolby Surround is ineffective with mono sources. With a 6-channel system, there is no sound from the front effect speakers.

2-6. SUPERIMPOSED VIDEO PROGRAM/PARAMETER DISPLAY

If you have connected your video cassette player or video disc player and video monitor to the DSP-100 as described in the "OPTIONAL CONNECTIONS" section on page 17, you can take advantage of the DSP-100's capability to provide a more comprehensive display of program and parameter data.

1. With the video monitor properly connected to the DSP-100 VIDEO OUT terminal and turned ON, press the ON SCREEN DISPLAY key on the remote control unit.

ON SCREEN
DISPLAY



The current program name and its parameters will be displayed on the monitor screen. The arrow-shaped cursor points to the currently selected parameter. Parameters are selected and edited using the PARAMETER UP/DOWN and INC/DEC keys as described previously.



SECTION 3—CREATING YOUR OWN SOUND FIELDS

3-1. SELECTING & EDITING PROGRAM PARAMETERS

WHAT IS A SOUND FIELD?

In order to explain the impressive functions of the DSP-100, let's go where it all begins, and find out what a sound field really is.

What really creates the rich, full tones of a live instrument are the multiple reflections from the walls of the room. In addition to making the sound "live," these reflections enable us to tell where the player is situated, and the size and shape of the room in which we are sitting. We can even tell whether it is highly reflective, with steel and glass surfaces, or more absorbent—wood panels, carpeting and curtains.

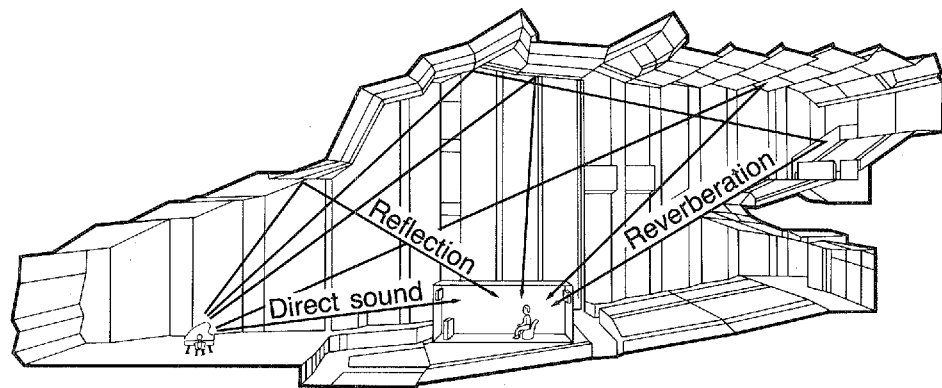

THE ELEMENTS OF A SOUND FIELD

In any environment, in addition to the direct sound coming straight to our ears from the player's instrument, there are two distinct types of sound reflections that combine to make up the sound field:

(1) Early Reflections. Reflected sounds that reach our ears extremely rapidly (50 ms—80 ms after the direct sound), after reflecting from one surface only—for example, from the ceiling or one wall. These reflections fall into specific patterns as shown in the following diagram for any particular environment, and provide vital information to our ears. Early reflections actually add clarity to the sound.

(2) Subsequent Reverberations. These are caused by reflections from more than one surface—walls, ceiling, the back of the room—so numerous that they merge together to form a continuous sonic "afterglow." They are non-directional, and lessen the clarity of any sound.

Direct sound, early reflections and subsequent reverberation taken together indicate to us very clearly the subjective size and shape of the room, and it is this information that the DSP-100 reproduces in order to create sound fields.

CREATING YOUR OWN SOUND FIELDS

If you could only create the appropriate early reflections and subsequent reverberations in your listening room, you would be able to create your own listening environment. The acoustics in your room could be changed to be those of a concert hall, a dance floor, or virtually any size room at all. This ability to create sound fields at will is exactly what Yamaha has done with the DSP-100.

In addition to allowing you to recreate the sound fields of famous listening environments from around the world, the DSP-100 also allows you to create your own sound fields. Starting with one of the built-in "preset" programs, you can adjust such parameters as apparent room size, liveness of the room, and distance from you to the performer. Up to 12 of your own sound fields can be stored in the DSP-100's memory for later use. The following pages detail how to make your own sound fields.

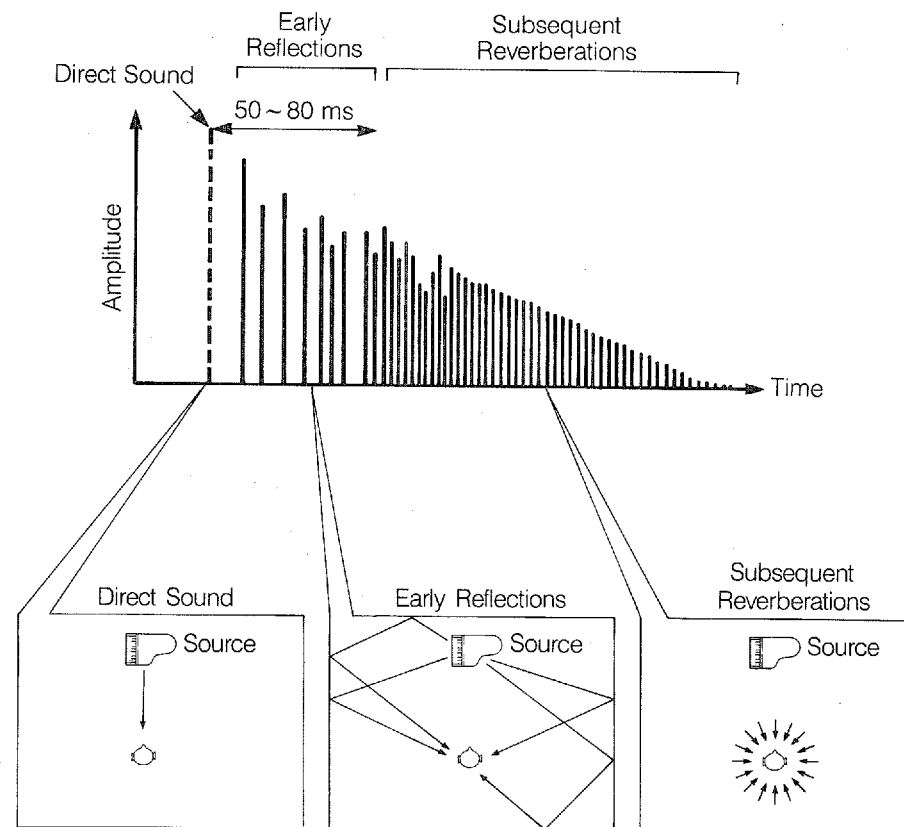

CREATING YOUR OWN SOUND FIELDS

In addition to the "TYPE" parameter which selects the sub-programs within each sound field program (e.g. "Hall A in Europe" and "Hall B in Europe" for program 1, CONCERT HALL 1), each program also has a set of parameters which allow you to change the characteristics of the acoustic environment to create precisely the effect you want. These parameters correspond to the many natural acoustic factors that create the sound field you experience in an actual concert hall or other listening environment. The size of the room, for example, affects the length of time between the "early reflections"—that is, the first few widely spaced reflections you hear after the direct sound. The "ROOM SIZE" parameter provided in many of the DSP-100 programs alters the timing between these reflections, thus changing the size of the "room" you hear. In addition to room size, the shape of the room and the characteristics of its surfaces have a significant effect on the final sound. Surfaces that absorb sound, for example, cause the reflections and reverberation to die out quicker, while highly reflective surfaces allow the reflections to carry on for a longer period of time. The DSP-100's parameters allow you to control these and many other factors that contribute to your personal sound field, allowing you to essentially "redesign" the concert halls and rooms provided to create custom-tailored listening environments that ideally match your mood and music.

Refer to "3-4. DESCRIPTIONS OF THE SOUND FIELD PARAMETERS" on page 37 for a description of what each parameter does, how it affects the sound, and its control range.

1. With the desired program selected, press the PARAMETER DOWN key on the remote control unit once. This will recall the next parameter after the program type. In the case of the CONCERT HALL 1 program, for example, this would be the INIT DELAY parameter. You can continue pressing the PARAMETER DOWN key until you reach the "bottom" of the parameter list and no more parameters appear. Press the PARAMETER UP key to scroll upward through the parameter list.

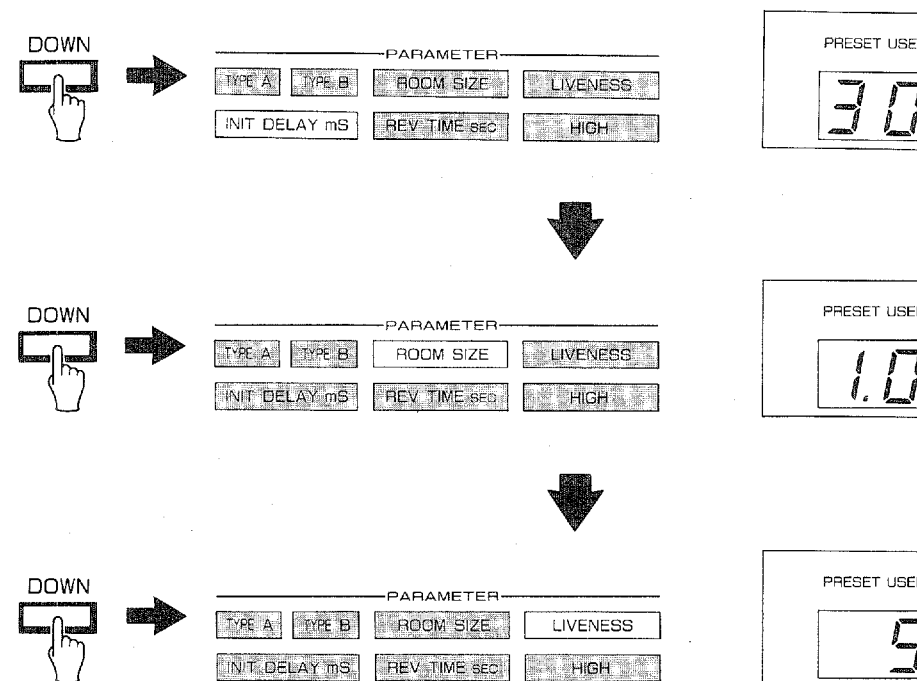

CREATING YOUR OWN SOUND FIELDS

2. When the desired parameter has been recalled, use the PARAMETER INC (increment) and DEC (decrement) keys to change its value to create the effect you want. INC increases the value of the selected parameter, and DEC decreases the value of the selected parameter. In both cases you can hold the key down for continuous incrementing or decrementing.

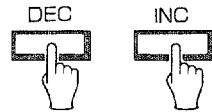

NOTE: Parameter edits made in this way will remain in effect only for as long as the current program is selected. If you select a different program and then re-select the edited program, all parameters will have been reset to their preset values. In order to save your edited program for instant recall later on, store it into a user memory location as described in "3-3. STORING AN EDITED PROGRAM IN THE USER MEMORY."

3-2. EFFECT LEVEL & BALANCE

These parameters can be used to individually adjust the effect level and front/rear effect balance for each program.

LEVEL

Use the EFFECT LEVEL DOWN and UP keys on the remote control unit to adjust the overall level of the effect signal (front and rear).



BALANCE

The balance between the front and rear effect speakers can be adjusted using the EFFECT BALANCE REAR and FRONT keys on the remote control unit. Pressing the REAR key decreases the level of the front speakers in relation to the rear speakers, while pressing the FRONT key decreases the level of the rear speakers in relation to the front speakers.

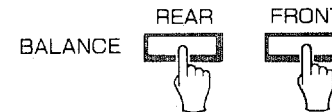

NOTE: The EFFECT LEVEL and BALANCE parameters affect only the selected program and NOT the overall system level and balance.

CREATING YOUR OWN SOUND FIELDS

3-3. STORING AN EDITED PROGRAM IN THE USER MEMORY

Once you've edited the parameters of one of the preset programs and created the sound you want, you can store your original program into one of the DSP-100's 12 USER memory locations so you can recall it again later without having to re-edit all the parameters individually.

1. After you've finished editing the preset program (do NOT switch to a different program), press the MEMORY key on the remote control unit. The USER program indicator and program number display will begin to flash.

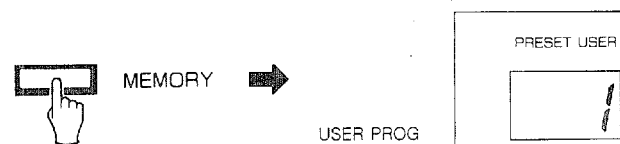

2. The USER program indicator and program number display will continue to flash for a few seconds. **WHILE THE INDICATOR AND DISPLAY ARE FLASHING**, press the number key corresponding to the memory location you wish to store the program to. If you press a program number key **AFTER** the indicator and display have stopped flashing, all your original parameter data will be erased and you'll have to re-edit the entire program. If the indicator and display stop flashing before you get a chance to press a memory number key, simply press the MEMORY key again.

3. To recall your original program, press the USER key followed by the number key corresponding to the number of the memory location to which you stored the edited program.

* The front-panel PROGRAM UP/DOWN key provides sequential access to both the PRESET and USER programs. Pressing the UP or DOWN end of the PROGRAM key increments (increases) or decrements (decreases) the selected program number, respectively. Hold down the UP or DOWN end of the key for continuous incrementing or decrementing.

NOTE: When you switch between the USER and PRESET programs, the DSP-100 automatically returns to the previously selected program number and any parameter changes you programmed.

CAUTION: If you store a new program to a user memory location which contains a previous program, the program originally contained in the user memory location will be erased and replaced with the new data.

CREATING YOUR OWN SOUND FIELDS

BATTERY BACKUP: The DSP-100 user memory is maintained by a special long-life backup battery even while the power is OFF. The battery should last for approximately five years. When the battery reaches a point where it can no longer safely maintain the user memory, "EE" will appear on the LED display when the DSP-100 is initially turned ON. When this happens, have the battery replaced by a qualified YAMAHA service center. It's a good idea to record the parameter values of your most important original programs in the "USER PARAMETER TABLE" given in the last section of this manual, so you can quickly re-program the DSP-100 should you lose your original programs due to a battery failure.

The preset programs cannot be erased or lost.

WARNING: DO NOT ATTEMPT TO REPLACE THE BACK-UP BATTERY YOURSELF

If the backup battery in the main unit should need replacement, have the job done by qualified Yamaha service personnel.

3-4. DESCRIPTIONS OF THE SOUND FIELD PARAMETERS

Not all of the following parameters are found in every program. Refer to the "PROGRAM PARAMETER TABLE" on page 41 for a complete list of the parameters contained in each program.

• ROOM SIZE

How it Affects the Sound:

Changes the apparent size of the listening room. The larger the value, the larger the simulated room will sound.

What it Does:

Adjusts the timing between the early reflections. Early reflections are the first group of reflections you hear before the subsequent, dense reverberation begins.

Control Range:

0.1—4.0.

Standard setting is 1.0.

Changing this parameter from 1 to 2 increases the apparent volume of the room eight times (length, width, and height all doubled).

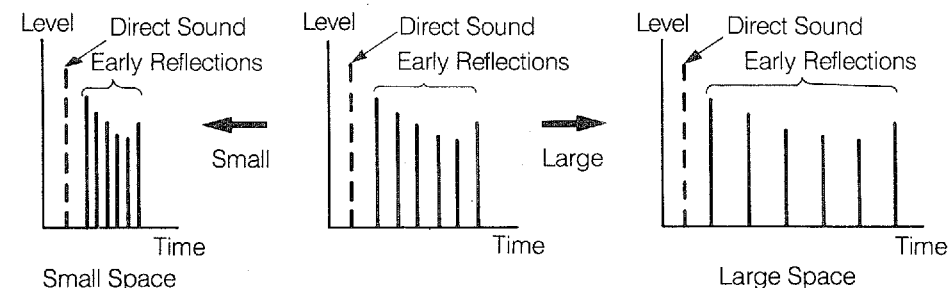

CREATING YOUR OWN SOUND FIELDS

• LIVENESS

How it Affects the Sound:

This parameter changes the apparent reflectivity of the walls in the hall.

The early reflections from a sound source will lose intensity (decay) much faster in a room with acoustically absorbent wall surfaces than in one which has mostly reflective surfaces. A room with highly reflective surfaces in which the early reflections decay slowly is termed "live," while a room with absorbent characteristics in which the reflections decay rapidly is termed "dead." The LIVENESS parameter lets you adjust the early reflection decay rate, and thus the "liveness" of the room.

What it Does:

Changes the rate at which the early reflections decay.

Control Range:

0—10.

Standard setting is 5.

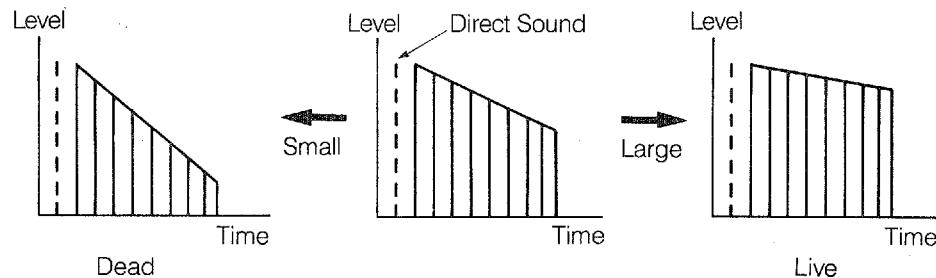

• INIT DELAY (Initial Delay)

How it Affects the Sound:

Changes the apparent distance from the source sound.

Since the distance of the sound source from a reflective surface determines the delay between the direct sound and the first reflection, this parameter changes the location of the sound source within the acoustic environment.

What it Does:

Adjusts the delay between the direct sound and the first reflection heard by the listener.

Control Range:

1—50 milliseconds.

For a small living room this parameter would be set between 4 and 5. Between 15 and 30 for a big hall. Larger values produce an echo effect.

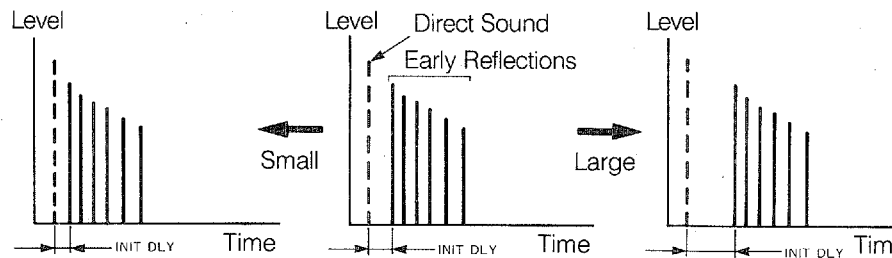

CREATING YOUR OWN SOUND FIELDS

• REV TIME (Reverberation Time)

How it Affects the Sound:

The natural reverberation time of a room depends primarily on its size and the characteristics of its inner surfaces. This parameter, therefore, changes the apparent size of the acoustic environment over an extremely wide range.

What it Does:

Adjusts the amount of time it takes for the level of the dense, subsequent reverberation sound to decay by 60 dB (@1 kHz).

Control Range:

0.1—8.0 seconds.

The reverb time in a standard living room would be about 0.3—1, in a small-to-medium size hall it would be between 1 and 2, and in a large hall it is normally between 2 and 3.

• HIGH (High Frequency Reverberation Time Ratio)

How it Affects the Sound:

Varies the amount of the high-frequency components of the reverberations.

What it Does:

Adjusts the cutoff frequency of the high-frequency reverberations.

Control Range:

0.1—1.0

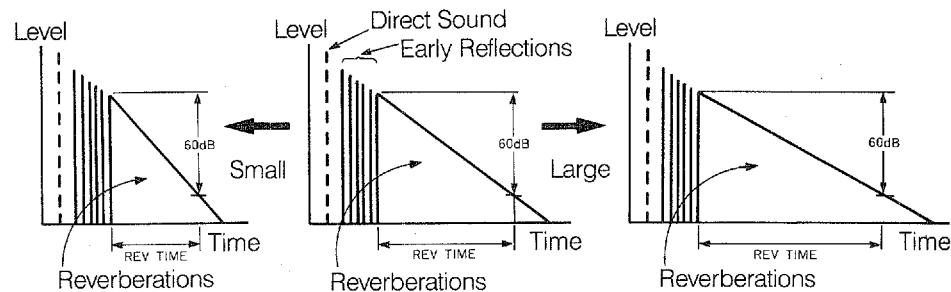

DOLBY SURROUND PARAMETERS

- **DELAY**

This parameter sets the time difference between the beginning of the source sound and the beginning of the effect sound. Simply adjust for the best effect.

Control Range:

15 ms—30 ms

- **INPUT BALANCE Control (Rear Panel)**

Normally the center (click) position is best, but for sources that are out of balance (off center), the following adjustment procedure will improve the Dolby Surround effect.

First, turn the volume of the main speakers and the front effect speakers (if you have a 6-channel setup) all the way down so that only the surround channel can be heard coming from the rear speakers (volume control on preamplifier, integrated amplifier or receiver for main speakers, volume control on additional amplifier for front effect speakers). Next select a MONO input such as AM radio or a MONO FM broadcast for the rear effects speakers. Now, adjust the rear panel INPUT BALANCE control for minimum surround channel output. Finally, restore the volume controls to their original settings.

SECTION 4—TABLES & SPECIFICATIONS

4-1. PROGRAM PARAMETER TABLE

No.	Program Name	Parameter Name	Minimum	Preset Value	Maximum	Effect	Type
1	CONCERT HALL 1	TYPE	Hall A in Europe/Hall B in Europe			Sub-program select	
		INIT DLY	1ms	← 30ms	→ 50ms	Apparent distance from sound source	
		ROOM SIZE	0.1	← 1.0	→ 4.0	Apparent size of hall	ER
		LIVENESS	0	← 5	→ 10	Apparent reflectivity of walls	
2	CONCERT HALL 2	TYPE	Hall C in Europe/Hall D in U.S.A.			Sub-program select	
		INIT DLY	1ms	← 30ms	→ 50ms	Apparent distance from sound source	
		ROOM SIZE	0.1	← 1.0	→ 4.0	Apparent size of hall	ER
		LIVENESS	0	← 5	→ 10	Apparent reflectivity of walls	
3	CONCERT HALL 3	TYPE	Hall E in Europe/Hall F in Europe			Sub-program select	
		INIT DLY	1ms	← 30ms	→ 50ms	Apparent distance from sound source	
		ROOM SIZE	0.1	← 1.0	→ 4.0	Apparent size of hall	ER
		LIVENESS	0	← 5	→ 10	Apparent reflectivity of walls	
4	CHURCH	INIT DLY	1ms	← 40ms	→ 50ms	Apparent distance from sound source	
		REV TIME	0.1s	← 2.5s	→ 8.0s	Reverberation time	REV
		HIGH	0.1	← 0.9	→ 1.0	High-frequency reverberation time	
5	CHAMBER	INIT DLY	1ms	← 15ms	→ 50ms	Apparent distance from sound source	
		REV TIME	0.1s	← 1.5s	→ 8.0s	Reverberation time	REV
		HIGH	0.1	← 0.7	→ 1.0	High-frequency reverberation time	
6	ROCK CONCERT	TYPE	The Roxy Theatre/Arena			Sub-program select	
		INIT DLY	1ms	← 15ms	→ 50ms	Apparent distance from sound source	
		ROOM SIZE	0.1	← 1.0	→ 4.0	Apparent room size	ER
		LIVENESS	0	← 9	→ 10	Apparent reflectivity of walls	

*Program types: ER = Early Reflection
 REV = Reverberation
 S = Surround
 M = Movie Theater

TABLES & SPECIFICATIONS

No.	Program Name	Parameter Name	Minimum	Preset Value	Maximum	Effect	Type
7	JAZZ CLUB 1	TYPE		Village Vanguard/Village Gate		Sub-program select	
		INIT DLY	1ms	← 20ms →	50ms	Apparent distance from sound source	ER
		ROOM SIZE	0.1	← 1.0 →	4.0	Apparent size of hall	
		LIVENESS	0	← 5 →	10	Apparent reflectivity of walls	
8	JAZZ CLUB 2	TYPE		Cellar Club/Cabaret		Sub-program select	
		INIT DLY	1ms	← 20ms →	50ms	Apparent distance from sound source	ER
		ROOM SIZE	0.1	← 1.0 →	4.0	Apparent size of hall	
		LIVENESS	0	← 5 →	10	Apparent reflectivity of walls	
9	DISCO	TYPE		New York/Tokyo		Sub-program select	
		INIT DLY	1ms	← 10ms →	50ms	Apparent distance from sound source	ER
		ROOM SIZE	0.1	← 1.0 →	4.0	Apparent room size	
		LIVENESS	0	← 6 →	10	Apparent reflectivity of walls	
10	MOVIE THEATER 1	TYPE		Adventure/Standard		Sub-program select	
		INIT DELAY	1ms	← 11ms →	50ms	Apparent distance from sound source, center channel	M
		ROOM SIZE	0.1	← 1.0 →	4.0	Apparent room size, center channel	
		LIVENESS	0	← 5 →	10	Apparent wall reflectivity, center channel	
11	MOVIE THEATER 2	TYPE		Live/Concert		Sub-program select	
		INIT DELAY	1ms	← 20ms →	50ms	Apparent distance from sound source, center channel	M
		ROOM SIZE	0.1	← 1.0 →	4.0	Apparent room size, center channel	
		LIVENESS	0	← 5 →	10	Apparent wall reflectivity, center channel	
12	DOLBY SURROUND	DELAY	15.0ms	← 20.0ms →	30.0ms	Time until the rear delay sound is produced	S

*Program types: ER = Early Reflection
 REV = Reverberation
 S = Surround
 M = Movie Theater

TABLES & SPECIFICATIONS

4-3. TROUBLESHOOTING

SYMPTOM	POSSIBLE CAUSE	CURE
Power does not come on.	AC cord not properly plugged in.	Carefully plug AC plug into outlet.
Hum.	Bad cable connection.	Firmly plug in all connection cables.
No sound.	Bad or incorrect input connection. Incorrect input source selection.	Check connections. Check DSP-100 and amp switch settings.
No sound from MAIN speakers.	Wrong amplifier settings.	Check amplifier operation.
No sound from EFFECT speakers.	EFFECT MUTE indicator is ON. Wrong amplifier settings. The DOLBY SURROUND program is being used with a mono source.	Press EFFECT MUTE key to turn MUTE OFF. Check amplifier operation. Use a different sound field program.
No front reflection sound.	In a 4-channel system, the FRONT MIX switch is set incorrectly.	Set the FRONT MIX switch to "4ch."
Reflection sound from the MAIN speakers in a 6-channel system even when the effect sound is turned OFF.	The FRONT MIX switch is set incorrectly.	Set the FRONT MIX switch to "6ch."
The sound field cannot be recorded.	It is not possible to record the sound field on a tape deck connected to the DSP-100 TAPE terminals.	
The remote control unit does not function properly.	Dead batteries. Wrong distance or angle.	Replace batteries. The remote control unit will function from a maximum range of 7 meters, no more than 30 degrees off-axis from the DSP-100 front panel.
Noise from nearby TV or tuner.	The DSP-100 is too close to the affected equipment.	Move the DSP-100 further away from the affected equipment.

TABLES & SPECIFICATIONS

4-4. SPECIFICATIONS

INPUT/OUTPUT CHARACTERISTICS

• INPUT	
Input Terminals	INPUT TAPE PB
Max. Input	2.5 V r.m.s (1 kHz)
Input Impedance	47 k Ω
• VIDEO INPUT	
Input Terminal	VIDEO IN
Input sens./ Impedance	1 V p-p/75 Ω
• OUTPUTS	
Output Terminals	TAPE REC MAIN OUTPUT EFFECT OUTPUT (FRONT/REAR) MONO OUTPUT (FULL BAND/LPF; fc=200 Hz)
Max. Output	2.5 V r.m.s (1 kHz)
Output Impedance	600 Ω (MAIN, FRONT, REAR)
• VIDEO OUTPUT	
Output Terminal	VIDEO OUT
Output Voltage	1 V p-p (75 Ω load)
Output Impedance	75 Ω
• OTHERS	
Output Gain	0 \pm 0.5 dB

A/D CONVERTER

• QUANTIZATION	16 bit linear
• SAMPLING FREQUENCY	44.1 kHz
• FEATURES	Independent L and R channels. Internal dither circuitry.

D/A CONVERTER

• QUANTIZATION	16 bit linear
• SAMPLING FREQUENCY	44.1 kHz

DSP PROGRAM

• PRESET	12 programs
• USER	12 programs

THD

• MAIN OUT	0.002% (1 kHz, 2.5 V)
• EFFECT OUT	0.015% (1 kHz, 2.5 V)
• EFFECT OUT (REAR, DOLBY)	0.04% (1 kHz, 2.5 V)

FREQUENCY CHARACTERISTICS

• MAIN	10 Hz—100 kHz +0, -3 dB
• EFFECT	20 Hz—20 kHz +0.5, -3 dB

S/N

• MAIN	110 dB (IHF/A NETWORK)
• EFFECT	92 dB (IHF/A NETWORK)

RESIDUAL NOISE

• MAIN, EFFECT	5 μ V (IHF/A NETWORK)
----------------	---------------------------

CHANNEL SEPARATION

• MAIN INPUT (Input terminated with 5.1 k Ω)	1 kHz, 65 dB (MAIN)
--	---------------------

OTHERS

• POWER SUPPLY	AC 120 V, 60 Hz
• POWER CONSUMPTION	20 watts
• AC OUTLET	Switched x1 200 W Max.
• DIMENSIONS (W x H x D)	435 x 75 x 319.5 mm
• WEIGHT	4.5 kg

TABLES & SPECIFICATIONS

4-5. BLOCK DIAGRAM

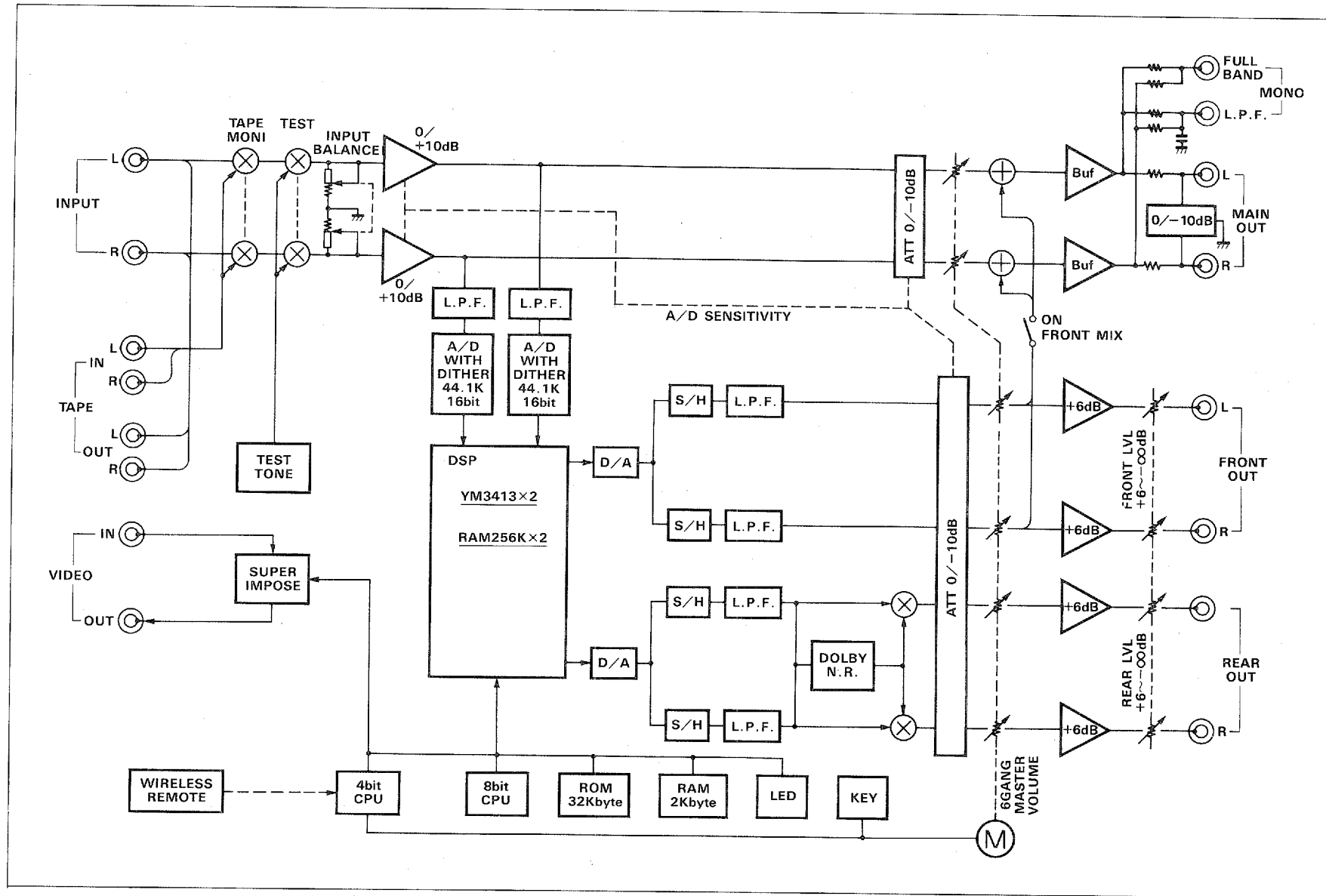

YAMAHA

YAMAHA CORPORATION
P.O. Box 1, Hamamatsu, Japan